

# INSTRUCTIONS FOR USE AND WARNINGS



TRANSLATION OF THE ORIGINAL INSTRUCTIONS



## FlexiBowl®

### Models 200 – 350 – 500 – 650 – 800

Manufactured Year	2020
-------------------	------

Revision 2.1 - Edition 03/2021



**ARS S.r.l.**

Via G. Vico, 7 – 52100 Arezzo (AR) Italia

Tel. +39 0575 398611 - Fax +39 0575 398620

info@arsautomation.com - www.arsautomation.com

## **INTRODUCTION**

All rights reserved. No part of this publication may be reproduced, distributed, translated into other languages or transmitted by any electronic or mechanical means, including photocopying, recording or any other storage and retrieval system, for any purposes other than solely for the personal use of the buyer, without the express written permission of the Manufacturer. The Manufacturer is in no way liable for the consequences resulting from any incorrect operations carried out by the user.

## **EDITOR'S NOTE**

This documentation is specifically intended for technicians; therefore, some of the information that can easily be understood from reading the texts and analysing the drawings might not be detailed further.

The Publisher is in no way responsible for the information and data in this manual: all of the information contained herein has been provided, checked and approved by the Manufacturer.

The Publisher is in no way liable for the consequences resulting from any incorrect operations carried out by the user.

## **GENERAL REMARKS**

All of the operating and maintenance instructions and recommendations described in this manual must be followed. To obtain the best results, the Manufacturer recommends that the cleaning and maintenance operations be carried out regularly to keep the system in perfect working order.

It is particularly important to train personnel in charge of the machine on its use, as well as on maintenance and monitoring compliance with the operating procedures and with all of the safety regulations set forth in this manual.

Revision: 2.1  
Edition: 03/2021

## Table of contents

<b>1</b>	<b>IDENTIFICATION.....</b>	<b>7</b>
1.1	Manufacturer's identification .....	7
1.2	Identification of the machine .....	7
1.3	Identification plate.....	8
1.4	CE Declaration of conformity (copy) .....	9
1.5	Reference directives .....	10
<b>2</b>	<b>GENERAL PRELIMINARY INFORMATION .....</b>	<b>11</b>
2.1	Recipients .....	11
2.2	Supply and storage .....	11
2.3	Updates.....	11
2.4	Language.....	11
2.5	Operators.....	12
2.6	Symbols used in the manual .....	13
2.7	Glossary .....	14
2.8	Personal protective equipment .....	15
2.9	User's safe area.....	16
2.10	Warranty.....	17
<b>3</b>	<b>SAFETY MEASURES .....</b>	<b>18</b>
3.1	Safety devices .....	18
3.2	Noise.....	19
3.3	Vibrations.....	19
3.4	Electromagnetic compatibility .....	19
3.5	Residual risks .....	20
3.6	Safety pictograms attached to the machine.....	22
<b>4</b>	<b>DESCRIPTION OF THE MACHINE .....</b>	<b>23</b>
4.1	Intended use (correct) .....	23
4.2	Reasonably foreseeable misuse .....	23
4.3	Obligations and prohibitions .....	24
4.3.1	Obligations of users .....	24
4.3.2	Obligations of personnel in charge (operators/maintenance technicians/technicians) .....	24
4.3.3	Prohibitions of personnel in charge (operators/maintenance technicians/technicians) .....	24
4.4	Technical specifications .....	25
4.5	Layouts .....	26
4.5.1	FlexiBowl® 200 .....	26
4.5.2	FlexiBowl® 350 .....	27
4.5.3	FlexiBowl® 500 - 650 - 800.....	28

4.6	Main components .....	29
4.7	Optional components.....	31
4.8	General description.....	35
4.8.1	Processing cycle.....	35
<b>5</b>	<b>TRANSPORT AND INSTALLATION .....</b>	<b>36</b>
5.1	Packaging .....	37
5.1.1	Table of units and weights - with packaging.....	37
5.1.2	Handling with packaging.....	38
5.1.3	Removing the packaging.....	39
5.1.4	Disposing of the packaging.....	39
5.2	Transport and handling.....	40
5.2.1	Table of units and weights .....	40
5.4	Installation .....	41
5.4.1	Preparations by the customer.....	41
5.4.2	Permitted environmental conditions .....	41
5.4.3	Installation site.....	42
5.4.4	Machine position.....	42
5.6	Connections.....	43
5.7	Electrical connection .....	43
5.7.1	Input pinout.....	45
5.7.2	Output pinout.....	46
5.7.3	Compressed air connection .....	47
5.7.4	Other connections.....	48
5.7.4.1	Air Blow connection (optional).....	48
5.7.4.2	Mapping of connections between the control devices.....	48
5.7.4.3	Connecting the user interface.....	49
<b>6</b>	<b>CONTROLS AND USE.....</b>	<b>50</b>
6.1	Description of the control panel.....	51
6.2	User interface - FlexiBowl® Parameters.....	52
6.2.1	Installing and using the FlexiBowl® Parameters program.....	52
6.2.2	Change IP address.....	53
6.2.3	IP address recovery.....	54
6.2.4	Home screen.....	56
6.2.4.1	Move .....	57
6.2.4.2	Shake.....	58
6.2.4.3	Option .....	59
6.2.5	Try Commands.....	60
6.2.6	Monitor.....	61

6.2.6.1	I/O Status.....	61
6.2.6.2	Driver Status.....	62
6.2.6.3	Alarm Status .....	63
6.2.7	Console.....	64
6.2.8	Reset Option .....	65
6.3	Operating procedures.....	66
6.3.1	Preliminary inspections .....	66
6.3.2	Start-up .....	66
6.3.3	Programming.....	66
6.3.3.1	Programming with TCP/IP - UDP protocol.....	67
6.3.3.2	Programming and handling via digital I/O.....	69
6.3.3.3	Programming with Ethernet/IP.....	70
6.3.4	Pressure adjustment.....	71
6.3.5	Switching off.....	71
<b>7</b>	<b>MAINTENANCE.....</b>	<b>72</b>
7.1	Safety warnings.....	73
7.2	Routine maintenance .....	74
7.2.1	Checks and inspections.....	75
7.2.1.1	Routine maintenance table - checks .....	75
7.2.1.2	Inspection of safety devices.....	76
7.2.1.3	Checking for wear of the drill.....	76
7.2.1.5	Checking for wear of the relays and status of the fuses.....	77
7.2.2	Replacing the FlexiBowl® Rotary disc .....	78
7.2.3	Cleaning.....	79
7.2.3.1	Routine maintenance table - cleaning .....	79
7.2.3.2	Cleaning the air filter .....	80
7.2.4	Cleaning the FlexiBowl® Rotary Disc.....	81
7.2.4.1	General cleaning .....	82
7.3	Unscheduled maintenance .....	83
7.3.1	Replacing the backlight .....	84
7.3.2	Replacing the solenoid valve .....	85
7.3.3	Replacing the anti-vibration mount.....	86
7.3.4	Replacing the Driver.....	87
7.3.5	Replacing the power supply unit .....	88
7.3.6	Replacing the motor .....	89
7.4	Troubleshooting.....	91
<b>8</b>	<b>DECOMMISSIONING AND DISPOSAL.....</b>	<b>93</b>
8.1	Decommissioning.....	93

8.3 Disposd.....94

**9 APPENDICES..... 95**

# 1 Identification

## 1.1 Manufacturer's identification

Manufacturer	ARS S.r.l.
Address	Via G. Vico, 7 52100 Arezzo (AR) - Italy Tel. +39 0575 398611 - Fax +39 0575 398620 info@arsautomation.com - www.arsautomation.com

## 1.2 Identification of the machine

Machine	FlexiBowl®
Model	200 - 350 - 500 - 650 - 800
Year of Manufacture	2020

### 1.3 Identification plate

The machine has an identification plate on its casing.

The plate bears the machine's identification data to be provided to ARS S.r.l. in case of need.

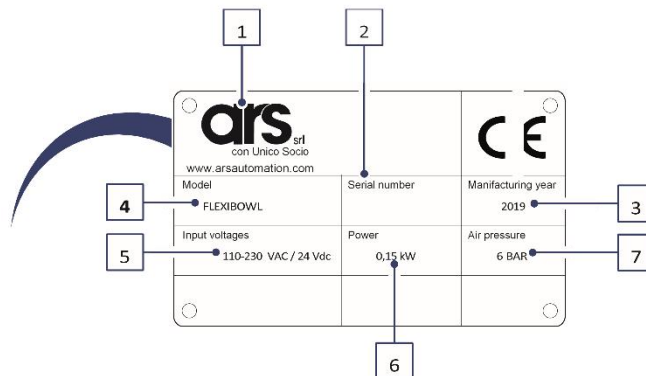

Pos.	Item
1	Manufacturer's logo
2	Serial no.
3	Year of manufacture
4	Machine model
5	Supply voltage
6	Power
7	Air pressure



**CAUTION!**

It is strictly forbidden to remove the CE plate and/or replace it with another plate. If the plate is damaged or removed accidentally, the customer must inform the Manufacturer.



## 1.4 CE Declaration of conformity (copy)



### "CE" DECLARATION OF CONFORMITY

We

**ARS S.r.l.**  
**Via G. Vico, 7**  
**52100 Arezzo (Italy)**

Declare under our exclusive responsibility that the Product:

***FLEXIBOWL® 200/350/500/650/800***

this declaration refers to, compliant with the following standards or with other regulations:

**DLGS 17/2010**  
**2006/42/EC: "Partly completed machinery"**

In compliance with the directive 17/2010 including the use of 2006/42/EC.

We also hereby declare that the machinery described above is intended to be incorporated into other machinery and must not be put into service until the relevant machinery into which it is to be incorporated has been declared in conformity with the essential health and safety requirements of Council Directive 2006/42/EC.

Place: Arezzo

Signature: 

Date: 26-FEB-2020

Full Name: Marco Mazzini

## 1.5 Reference directives

The machine supplied by **ARS S.r.l.** does not fall under one of the machine categories listed in Annex IV of the Directive; therefore, for the purpose of certifying compliance of the machine with the provisions of this Directive, **ARS S.r.l.** applies the conformity assessment procedure with internal control on the manufacture of machinery, as set forth in Annex VIII.

To certify compliance of the machine with the provisions of the Directive, before placing it on the market **ARS S.r.l.** carried out the risk assessment in order to ascertain compliance with the essential health and safety requirements of the Directive as well as the tests and inspections required by the applicable reference standards.

The technical construction file was prepared in compliance with the provisions of Annex VII of **Directive 2006/42/EC** and is available for inspection by the supervisory bodies upon a reasoned request, as required by the legal provisions in force.

ARS S.r.l. therefore places the machine on the market together with:

<b>CE Marking</b>	
<b>CE Declaration of Conformity</b>	
<b>Instruction manual and safety warnings</b>	(Documentation prepared according to section 1.7.4 of Machinery Directive 2006/42/EC)

it should also be noted that the machine has been designed in compliance with the following Directives:

<b>2006/42/EC</b>	Machinery Directive
<b>2014/30/EU</b>	Electromagnetic Compatibility Directive

## 2 General Preliminary Information

### 2.1 Recipients

**The manual is intended for operators in charge of using and controlling the machine throughout all stages of its technical life.** It contains topics that refer to correct use of the machine, in order to maintain its functional and qualitative features unchanged over time. It also contains all of the information and warnings needed for safe and correct use. The manual, like the EC certificate of conformity, is an integral part of the machine and must always accompany it if it is relocated or resold. It is the responsibility of the user to keep this documentation intact so that it can be consulted throughout the machine's service life.

### 2.2 Supply and storage

The manual is supplied in **electronic** format.

All of the additional documentation (wiring and pneumatic diagrams, sub-supplier manuals) can be provided at the customer's request.

Store this manual with the machine so that it can be easily referenced by the operator.

The manual is intended to guarantee safety, therefore:

- **it must be stored intact** (in its entirety). If it is lost or damaged, immediately ask for another copy.
- **it must be kept with the machine until it is scrapped** (even if it is relocated, sold, hired, etc.);
- **the attached manuals are an inherent part of this documentation**, therefore the same recommendations/requirements contained in this manual apply to them.

The **Manufacturer** disclaims any liability for machine misuse and/or for damage caused following operations not specified in the technical documentation.

### 2.3 Updates

If the machine requires modifications or functional replacements, the Manufacturer is responsible for reviewing or updating the manual. The Manufacturer is in charge of delivering the updated manual.

Moreover, if this document is altered in any way by the Manufacturer, the user is responsible for ensuring that only the updated version of the manual is actually made available in the places of use.

### 2.4 Language

The original manual is written in **Italian**.

Any translations into additional languages must be done from the original instructions.

The Manufacturer is responsible for the information in the original instructions; translations into different languages cannot be completely verified, therefore, if an inconsistency is found, one must adhere to the text in the original language or contact our Technical Documentation Department.

## 2.5 Operators

In order to establish with certainty what the skills and qualifications are of the operators assigned to the various tasks (start-up, cleaning, routine maintenance), see the table below:

Qualification	Definition
<b>Operator</b>	<p>User's trained personnel who are qualified to use and run the machine for production purposes for the activities it was built and supplied for.</p> <p>He/she must be able to perform all of the operations required for smooth operation of the machine and to safeguard himself/herself and any co-workers. He/she must have proven experience on correct use of this kind of machine and be duly trained, informed and instructed.</p> <p>If in doubt, he/she must report any anomalies to his/her supervisor.</p> <p><b>Note:</b> he/she is not authorised to carry out any maintenance work.</p>
<b>Mechanical Maintenance Technician</b>	<p>Qualified technician able to carry out preventive/corrective maintenance work on all mechanical parts of the machine subject to maintenance or repairs.</p> <p>Qualified technician able to access all parts of the machine for visual inspections, checking equipment conditions, adjustments and calibrations.</p> <p>Qualified technician able to:</p> <ul style="list-style-type: none"> <li>• run the machine like an operator;</li> <li>• work on the mechanical parts for adjustments, maintenance and repairs;</li> <li>• read pneumatic and hydraulic diagrams, technical drawings and spare parts lists.</li> </ul> <p>In extraordinary cases, he/she is trained to operate the machine with reduced safety devices.</p> <p>Where necessary, he/she can give the operator instructions on how to use the machine properly for production purposes.</p> <p><b>Note:</b> he/she is not qualified to work on live electrical systems (if any).</p>
<b>Electrical Maintenance Technician</b>	<p>Qualified technician able to carry out preventive/corrective maintenance work on all electrical parts of the machine subject to maintenance or repairs.</p> <p>Qualified technician able to access all parts of the machine for visual inspections, checking equipment conditions, adjustments and calibrations.</p> <p>Qualified technician able to:</p> <ul style="list-style-type: none"> <li>• run the machine like an operator;</li> <li>• work on the adjustments and electrical systems for maintenance, repairs and replacement of worn parts;</li> <li>• read the wiring diagrams and ensure that the functional cycle is correct.</li> </ul> <p>Where necessary, he/she can give the operator instructions on how to use the machine properly for production purposes.</p> <p>He/she can work with live voltage in the electrical panels, junction boxes, control equipment, etc. only if he/she is a person in charge of an electrical installation (SP, suitable person). (See standard <b>EN50110-1</b>).</p> <p>He/she does not program system software such as: PLC (logic or safety), and cannot change system passwords.</p>



<b>Expert software technician</b>	<p>Qualified technician able to:</p> <ul style="list-style-type: none"> <li>• carry out preventive/corrective work on all software parts of the machine;</li> <li>• access all parts of the machine for visual inspections, checking equipment conditions, adjustments and calibrations.</li> </ul> <p>Manufacturer's qualified technician with proven experience and training on systems based on: PLC/PC drives, etc. (knowledge of programming, machine functions, etc.) for complex operations such as:</p> <ul style="list-style-type: none"> <li>• changing machine data;</li> <li>• creating work programs;</li> <li>• adjustment of drive parameters, etc. as he/she knows the production, technological and construction cycle of the supplied machine.</li> </ul> <p>He/she can work in the electrical panels, junction boxes, control equipment, etc. with live voltage only if he/she is a person in charge of an electrical installation (i.e. suitable person - SP) (Refer to <b>EN50110-1</b>).</p> <p>The skills are electronic and/or software-based.</p>
<b>Manufacturer's Technician</b>	<p>Qualified technician employed by the Manufacturer and/or its supplier for complex operations, as he/she knows the construction production cycle of the machine.</p> <p>This person intervenes following requests from the user.</p> <p>The skills are mechanical-based.</p>

The qualifications indicated in the table on this page obligatorily fall under a category of persons defined as **"trained person"**.

<b>Type</b>	<b>Definition</b>
<b>Trained Person</b>	<p>An individual who has been informed, instructed and trained on the job and on any hazards resulting from misuse. He/she also knows the importance of the safety devices, the accident prevention regulations and the safe working conditions.</p>

## 2.6 Symbols used in the manual

In order to establish with certainty what the skills and qualifications are of the operators assigned to the various tasks (start-up, cleaning, routine maintenance), see the table below:

<b>Symbol</b>	<b>Definition</b>
	<p>Symbol used to identify important warnings for the safety of the operator and/or the machine.</p>
	<p>Symbol used to identify electrical hazards.</p>
	<p>Symbol used to identify important information in the manual. The information also concerns the safety of personnel involved in machine use.</p>

## 2.7 Glossary







Technical terminology or terminology with an uncommon meaning is used in the manuals. The terms and abbreviations used are explained below:

Term	Definition
<b>Lifting accessories</b>	Component or equipment not attached to the lifting machinery, allowing the load to be picked up, which is placed between the machinery and the load or on the load itself, or which is intended to become an integral part of the load and independently placed on the market. Slings and their components are also regarded as lifting accessories.
<b>Failure</b>	Different kinds of faults that prevent normal operation of machinery, of a system, etc.
<b>Chains, ropes and webbing</b>	Elements designed and built for lifting purposes as part of lifting machinery or lifting accessories.
<b>Harm</b>	Any negative consequence deriving from the occurrence of a hazardous event.
<b>P.P.E.</b>	Personal Protective Equipment (PPE) is clothing or equipment designed to protect the worker (operator, maintenance technician, technician, etc.) wearing it or carrying it against health and safety hazards.
<b>Machine</b>	An assembly, fitted with or intended to be fitted with a drive system, consisting of linked parts or components, at least one of which moves, and which are joined together for a specific application.
<b>Malfunction</b>	Defective or inadequate operation of a machine or its element in performing a certain function.
<b>Hazard</b>	Potential source of injury or damage to health.
<b>Safeguard</b>	Defence against what could cause harm. An element that is placed between who may be harmed and what can cause said harm due to hazards which cannot reasonably be eliminated or from the risks which cannot be sufficiently reduced by inherently safe design measures. Identified as follows: <ul style="list-style-type: none"> <li>• active safeguard that the operators themselves must activate (for example emergency stops) and/or wear (PPE);</li> <li>• passive safeguard that intervenes without human control.</li> </ul>
<b>Guard</b>	Physical barrier, designed as part of the machine to provide protection.
<b>Risk</b>	Combination of the probability and the degree of an injury or damage to health that can arise in a hazardous situation.
<b>Residual risk</b>	Risk remaining after protective and preventive measures have been implemented.
<b>Intended use</b>	Use of machinery in accordance with the information provided in the instructions for use.
<b>Reasonably foreseeable misuse</b>	Use of machinery in a way not intended by the designer, but which may result from readily predictable human behaviour.

## 2.8 Personal protective equipment

When working close to the machine, either for assembly operations or for maintenance and/or adjustments, it is necessary to fully comply with the general accident prevention regulations; for this reason, it is important to use the personal protective equipment (P.P.E.) required for each operation.

Below is a full list of the **personal protective equipment (P.P.E.)** that may be required for the different procedures:

Symbol	Description
	<b>Obligation to wear safety or insulating gloves.</b> Indicates a requirement for personnel to wear safety or insulating gloves.
	<b>Obligation to wear safety glasses.</b> Indicates a requirement for personnel to wear safety glasses to protect the eyes.
	<b>Obligation to wear safety shoes.</b> Indicates a requirement for personnel to wear safety shoes to protect the feet.
	<b>Obligation to wear noise protection devices.</b> Indicates a requirement for personnel to wear earmuffs or earplugs to protect hearing.
	<b>Obligation to wear protective clothing.</b> Indicates a requirement for personnel to wear specific protective clothing.
	<b>Obligation to read the instruction manual/booklet.</b> Indicates a requirement for personnel to read (and understand) the instructions for use and safety warnings for the machine before using it.

The clothing for operators and line maintenance technicians must comply with the essential safety requirements defined by **EU Regulation 2016/425** and the laws in force in the country of installation.

## 2.9 User's safe area

The areas around the machine are divided as follows:

Term	Description
<b>Control zones</b>	These are the areas where the user and the other operators can control the machine's cyclic functions (" <b>operator station</b> "), in either automatic mode or semi-automatic mode, with the control panels or to perform manual operations.
<b>Maintenance / adjustment zones</b>	These are the areas where the mechanical maintenance technicians can carry out maintenance work or adjustments. These areas are considered hazardous and not accessible during normal machine operation. Operators must be fully aware of the safety warnings and personal protective equipment to be worn.
<b>Danger zones</b>	These are any zones within (or around) the machine where there are residual risks that can cause harm to people. In these zones, access is forbidden to everyone during machine operation.

The hazards and risks in these areas are protected, as much as possible, with **guards** (casings, doors) and with **safety devices** (sensors, micro switches, light curtains) which, if activated, completely shut down the machine.

However, when the machine is running, **it is strictly forbidden to work in the danger zones as some of the risks might not have been completely eliminated.**



## 2.10 Warranty

**The full warranty terms are included in the sales contract.**

The conditions set forth in the sales contract (if different) have priority over the contents of this section.

The warranty is **subject** to the following general conditions:

- **opening of the packages** by using suitable devices and being careful not to damage the system;
- **installation and start-up** must be carried out in the presence of qualified and adequately trained technicians, according to the requirements provided herein;
- **the machine must be used within the limits declared** in the contract and specified in the technical documentation;
- **maintenance** must be carried out within the times and in the ways indicated in the manual, using original **ARS S.r.l.** spare parts and assigning the operations to qualified personnel;

The warranty shall be rendered **null and void** in the event of:

- failure to comply with the **safety regulations**;
- failure by the user to request any **authorisations required by the applicable regulations for use**;
- installation and use of the machine in **unsuitable premises**;
- **removal of or tampering with** the monitoring and safety devices (guards, photocells, sensors, micro switches, etc.);
- **removal of or tampering with** the identification plate;
- **removal of or tampering with** the safety pictograms affixed to the machine;
- **changes to the safety conditions** established by the Manufacturer in the machine control software;
- **misuse** of the machine;
- use of the machine by **untrained and/or unauthorised personnel** or failure to comply with the required skills of the various operators, as indicated in the manual;
- **modifications or repairs** made by the user without written authorisation from the Manufacturer;
- **tampering with** the machine's electrical or compressed air circuits;
- partial or total **failure** to comply with the instructions;
- **power supply faults** (electrical, compressed air, etc.);
- **failure to implement the maintenance plan** of the machine;
- **use of non-original spare parts** or incorrectly ordering them;
- disposal of the machine not in compliance with the regulations in force;
- exceptional events such as floods, fire (if not caused by the machines).



**IMPORTANT!**

**Further details may be contained in the sales contract.**

**The conditions set forth in the sales contract (if different) have priority over the contents of this section.**

### 3 Safety measures

#### 3.1 Safety devices

To fully safeguard the operator and prevent access inside the machine while it is moving, the machine has been fitted with a number of **safety devices** which, if they are activated, completely shut down the machine. The machine is designed and fitted with safety systems to minimise risks for the operator.

The machine features the safety devices described in the table below. For the position of these devices, see the drawing on the next pages.

Pos.	Item	Description
1	<b>COVERS</b>	These consist of fixed perimeter protections (casings), which have the function of preventing access to the movements of the various machine parts during the operating cycle and which can only be removed with specific tools.
2	<b>ELECTRICAL SWITCH</b>	It is located on the control panel and is used to cut off the power supply in the event of: <ul style="list-style-type: none"> <li>• danger to the operator's safety;</li> <li>• electrical hazard on the machine;</li> <li>• mechanical or electrical operations on the machine.</li> </ul>



**CAUTION!**

Due to the presence of spikes on the Rotary Discs, the operator could be exposed to the bruising and/or cutting hazard in case of contact with them. Wear the appropriate P.P.E. when working near these Rotary Discs.



**CAUTION!**

In case of emergency, disconnect the power supply connected to the control panel to safely disable the FlexiBowl® controls.

### 3.2 Noise

The noise was measured in compliance with the provisions of **UNI EN 11200** and **UNI EN ISO 3746**. During the operating cycles, **staff are exposed to a noise level of 90 dB**.

The actual noise level during operation of the machine installed on site in a production process is different from the one measured because the noise is affected by a number of factors, such as:

- type and characteristics of the site;
- type of machine that FlexiBowl® is installed on;
- other adjacent machines in operation.



#### **OBLIGATION!**

**It is mandatory to use the appropriate personal protective equipment.**

### 3.3 Vibrations

The vibrations produced by the machine, based on its operating mode, **are not dangerous** to the health of the operators.



#### **CAUTION!**

**Excessive vibrations can only be caused by a mechanical breakdown that must immediately be reported and fixed, so as not to undermine the safety of the line or of the operators.**

### 3.4 Electromagnetic compatibility

The supplied machine contains electronic components subject to the regulations on Electromagnetic Compatibility, affected by conducted and radiated emissions.

The emission values are within the regulatory requirements thanks to the use of components that comply with the Electromagnetic Compatibility directive, suitable connections and installation of filters where necessary.

Thus, the machine complies with the Electromagnetic Compatibility (EMC) directive.



#### **CAUTION!**

**Any non-compliant maintenance work carried out on the electrical equipment or incorrect replacement of components may undermine the efficiency of the implemented solutions.**





### 3.5 Residual risks

The machine is designed to guarantee the essential safety requirements for the operator.

Safety has been integrated into the design and construction of the machine as much as possible; however, some risks still remain, that operators must be protected from, especially during:

- transport and installation;
- normal operation;
- adjustment and setting up;
- maintenance and cleaning;
- disassembly and dismantling.

Below is a description of every residual risk, the area or part of the machine subject to the risk (unless the whole machine is subject to the risk) and the procedural information on how to avoid it:

Risk	Description and procedural information
<p><b>HAZARDS DUE TO HANDLING</b></p> <p>PICTOGRAMS:</p> 	<p>The handling procedures are described in the “<b>Transport and installation</b>” chapter in this instruction manual.</p> <p><b>Residual risk:</b></p> <p>These operations:</p> <ul style="list-style-type: none"> <li>• unloading the packaging,</li> <li>• opening the packaging,</li> <li>• handling the machine</li> </ul> <p>expose the operators to the risk of suspended loads and crushing.</p> <p>These operations must only be carried out by personnel skilled in using lifting equipment and who have been appropriately trained for this purpose.</p>
<p><b>ABRASION, CUTTING, IMPACT HAZARD</b></p> <p>PICTOGRAMS:</p> 	<p>Due to the presence of spikes on the <b>Rotary Disc</b>, the operator could be exposed to the bruising and/or cutting hazard in case of contact with them.</p> <p>Wear the appropriate P.P.E. when working near these <b>Rotary Disc</b>.</p>
<p><b>ELECTRICAL HAZARD</b></p> <p>PICTOGRAMS:</p> 	<p>Maintenance operations and access to the machine expose the operators to an electrical risk. Work on live equipment must only be carried out by expert and qualified personnel.</p> <p>These safety measures should be followed:</p> <ul style="list-style-type: none"> <li>• pay the utmost attention to the safety pictograms related to electrical hazards;</li> <li>• do not carry out maintenance work before having cut off the power;</li> <li>• refer to the trade equipment manuals for any specific instructions;</li> <li>• periodically inspect the equipotential bonding circuit, making sure there are no discontinuities and tightening the connection junction screws.</li> </ul>
<p><b>LIGHTING HAZARD</b></p> <p>PICTOGRAMS:</p> 	<p>The backlight is inside the machine body, out of view of the operator, and is almost completely shielded by the guards protecting the machine’s body.</p> <p><b>Residual risk:</b></p> <p>The operator may suffer eye damage if looking at the intense light of the lamp for a long time.</p>
<p><b>HAZARD FROM DUST, FRAGMENTS, ETC.</b></p> <p>PICTOGRAMS:</p> 	<p>At the end of the work cycle, there may be residues of fed-in parts or dust buildup on the machine <b>Rotary Disc</b>.</p> <p>Thoroughly clean the vibrating <b>Rotary Disc</b> after every use, as described in chapter 7 of this manual.</p>

**CAUTION!**

Do not carry out any maintenance or cleaning operations unless the energies have been de-energised.

**CAUTION!**

It is strictly forbidden to remove the safety protections installed on the machine or open the fixed guards before having disconnected the machine's electrical and air supply.

It is the responsibility of the user to:

- **analyse the risks that might occur while handling and installing at one's premises** (the analyses carried out on machine handling were made only taking into account its characteristics);
- **raise awareness and instruct the personnel involved in the operations on the work stations** and the personnel involved in running the machine;
- **affix visual safety signs around the workplace** after assessing the risks in the transit or control areas.

### 3.6 Safety pictograms attached to the machine

The machine has a number of pictograms attached to it, the purpose of which is to warn the operator of any residual risks.



**CAUTION!**



It is strictly forbidden to remove the warning plates from the machine. ARS S.r.l. disclaims all liability regarding machine safety if this prohibition is not complied with.



**CAUTION!**

The user must replace the warning plates which may become illegible as a result of wear.

The table below lists the pictograms on the machine. Refer to the picture for their position.

Pos.	Pictogram	Description
1		<p><b>DANGER! MAINTENANCE AND REPAIR TO BE PERFORMED BY AUTHORISED PERSONNEL ONLY.</b></p> <p>Indicates a prohibition for unauthorised personnel to perform maintenance work or repairs.</p>
2		<p><b>CAUTION! BEFORE CLEANING OR SERVICING, DISCONNECT POWER SUPPLIES.</b></p> <p>Indicates a prohibition to perform maintenance or cleaning operations before disconnecting the power supply.</p>



## 4 Description of the Machine

### 4.1 Intended use (correct)

FlexiBowl® is available in five models: **200, 350, 500, 650** and **800**.

The machine in question is designed for industrial use for:

Operation	Permitted	Not permitted	Processing environment
<b>HANDLING AIMED AT PICKING UP:</b>	Components of maximum variable weight and dimensions according to the machine model.	Any other component not included in the permitted range of maximum weight and dimensions.	Industrial.



**IMPORTANT!**

**For more information on the type of components permitted, see the “Technical specifications” section in this manual.**

The machine is designed to:

- meet the specific requirements indicated in the sales contract;
- be used according to the instructions and limits of use given in this manual.

The machine is designed and built to safely work if:

- it is used within the limits stated in the contract and in this manual;
- the procedures in the instruction manual are followed;
- routine maintenance is carried out within the times and in the ways indicated;
- unscheduled maintenance is promptly carried out if required;
- the safety devices are not removed and/or bypassed.

### 4.2 Reasonably foreseeable misuse

**Reasonably foreseeable misuse** is described below:

- processing liquids and fine granules;
- changing any safety-related work parameters;
- transporting people;
- using the machine as a support point;
- using the machine to obtain production values above the prescribed limits;
- changing / tampering with the machine’s electrical and compressed air connections or any of its other components;
- using the machine with a product that is not listed in the “**Intended (correct) use**” section;
- using the machine in a way that is not specified in the “**Intended (correct) use**” section.

Any other machine use that is not specified must be authorised in writing beforehand by the Manufacturer. In the absence of this written authorisation, the use is considered “**misuse**”; therefore, the Manufacturer disclaims any liability for damage caused to property or people and deems every type of machine warranty null and void.



**IMPORTANT!**

**Misuse of the machine excludes any liability of the Manufacturer**

## 4.3 Obligations and prohibitions

### 4.3.1 Obligations of users

The user (contractor or employer) must:

- take into account the skills and conditions of the operators in relation to their health and safety;
- provide the personal with protective equipment adequate for the individual procedures;
- provide standard lifting means and procedures;
- ensure that individual workers respect the company rules and regulations on safety and on use of the collective and personal protective equipment available;
- instruct personnel on the procedures in case of an accident;
- instruct personnel on existing residual risks;
- instruct personnel on the devices set up for operator safety;
- instruct personnel on the hazards due to noise emission in the workplace;
- instruct personnel on the general accident prevention rules set forth by European directives and by the legislation in the country of destination of the machine.

**Only allow personnel who have read this manual and are properly trained to work on the machine.**

### 4.3.2 Obligations of personnel in charge (operators/maintenance technicians/technicians)

Personnel **must**:

- Only carry out maintenance work with the machines switched off. Not lubricate moving parts.
- When the machine is in operation, they must not work near it wearing necklaces, bracelets, neck ties, or other clothing that could get caught in the mechanisms.
- Operators with long hair must tie it back to prevent it from getting entangled.
- Only work on the electrical panel, on the junction boxes, on the cables and on all electrical components with the main switch turned off.
- When starting the machine, make sure there is nobody inside the danger zones.
- During operation, pay the utmost attention that nobody can directly access the moving parts.
- Use the protective devices provided by the employer properly.
- Immediately report any safety device faults to the employer, manager or supervisor.

### 4.3.3 Prohibitions of personnel in charge (operators/maintenance technicians/technicians)

Personnel **must not**:

- use the machine improperly, i.e. for uses that are not specified in the “**Intended Use**” section;
- remove or change the safety devices or signs without authorisation;
- carry out operations or manoeuvres of their own initiative which do not fall under their responsibility or which can compromise personal safety or that of other workers;
- wear bracelets, rings, necklaces that can dangle and be dragged by moving parts, thereby creating danger for the operator;
- replace or change the speeds of the machine’s components without authorisation from a manager;
- change the machine cycle;
- change the electrical connections to exclude the internal safety devices;
- use the machine if it has not been installed in compliance with applicable regulations;
- use the machine as a support point even if it is not working (with a risk of falling and/or damaging the machine);
- use the machine outside of the permitted environmental conditions (see “**Chapter 5**”).



**CAUTION!**

**ARS S.r.l. shall not be held liable for damage caused to property or people if:**

- **it is ascertained that the machine was used in one of the unpermitted environments;**
- **the obligations and prohibitions described herein have not been followed**



#### 4.4 Technical specifications

Power supply specifications	
Power supply	110 - 220Vac +/-5%
Frequency / Phasing	50-60 Hz / 1 phase
230 VAC current	6 A

Air supply specifications	
Air pressure	6 bar
Air characteristics	<ul style="list-style-type: none"> <li>• Dried</li> <li>• Filtered</li> </ul>

General specifications	FlexiBowl® 200	FlexiBowl® 350	FlexiBowl® 500	FlexiBowl® 650	FlexiBowl® 800
Backlit area dimensions	90 cm <sup>2</sup>	166 cm <sup>2</sup>	513 cm <sup>2</sup>	922 cm <sup>2</sup>	1125 cm <sup>2</sup>
Infrared backlight	20,000 – 30,000 hours; 850 nm LED				
Ethernet ports	1				
Digital I/O	13 inputs, 3 outputs				

Weight	FlexiBowl® 200	FlexiBowl® 350	FlexiBowl® 500	FlexiBowl® 650	FlexiBowl® 800
Net weight	18 Kg	25 Kg	42 Kg	54 Kg	71 Kg

Component specifications	FlexiBowl® 200	FlexiBowl® 350	FlexiBowl® 500	FlexiBowl® 650	FlexiBowl® 800
Maximum single component dimension	10 mm	20 mm	50 mm	110 mm	250 mm
Maximum single component weight	20 g	40 g	100 g	170 g	250 g
Maximum loading capacity	1 Kg	3 kg	7 kg	7 kg	7 kg

## 4.5 Layouts

### 4.5.1 FlexiBowl® 200

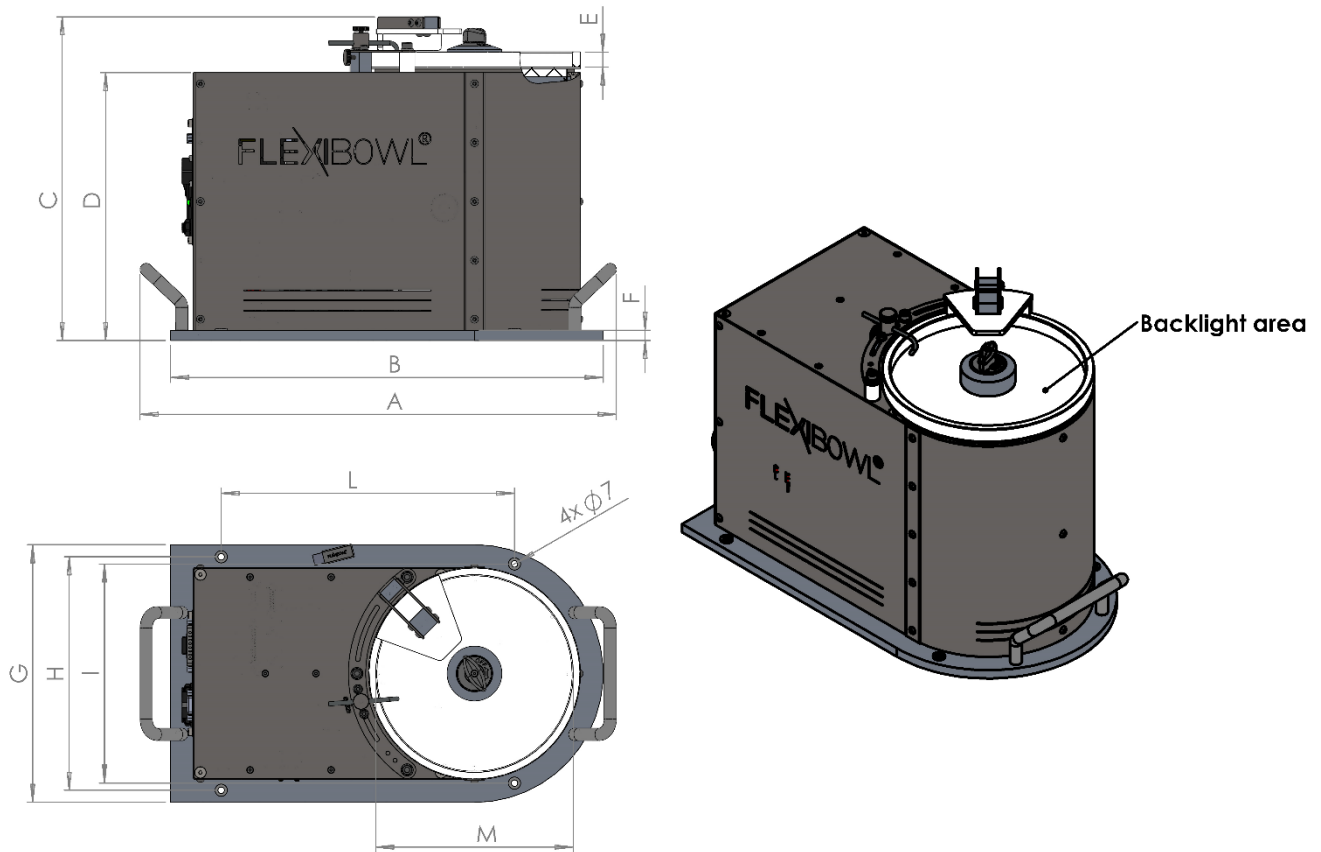

Reference	FlexiBowl® 200
A	470 mm
B	427 mm
C	319 mm
D	264 mm
E	15 mm
F	10 mm
G	254 mm
H	230 mm
I	216 mm
L	289.5 mm
M	193 mm
N	90,5mm
O	180mm
<b>Backlight Area</b>	9000 mm <sup>2</sup>

### 4.5.2 FlexiBowl® 350

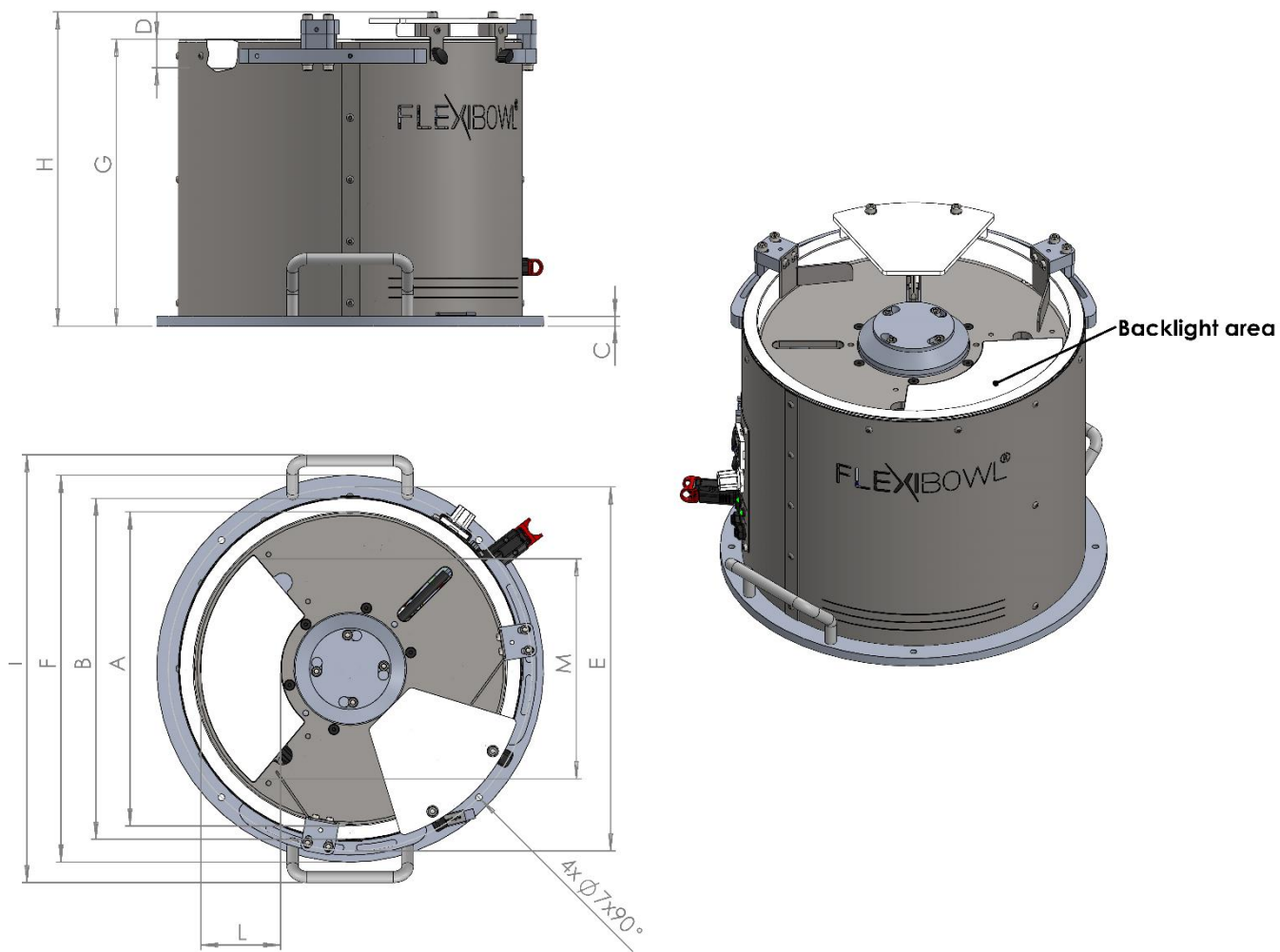

Reference	FlexiBowl® 350
A	328 mm
B	357 mm
C	10 mm
D	31,5 mm
E	380 mm
F	404 mm
G	299,5 mm
H	328 mm
I	447 mm
L	78,5 mm
M	230 mm
<b>Backlight Area</b>	16600 mm <sup>2</sup>

### 4.5.3 FlexiBowl® 500 - 650 - 800

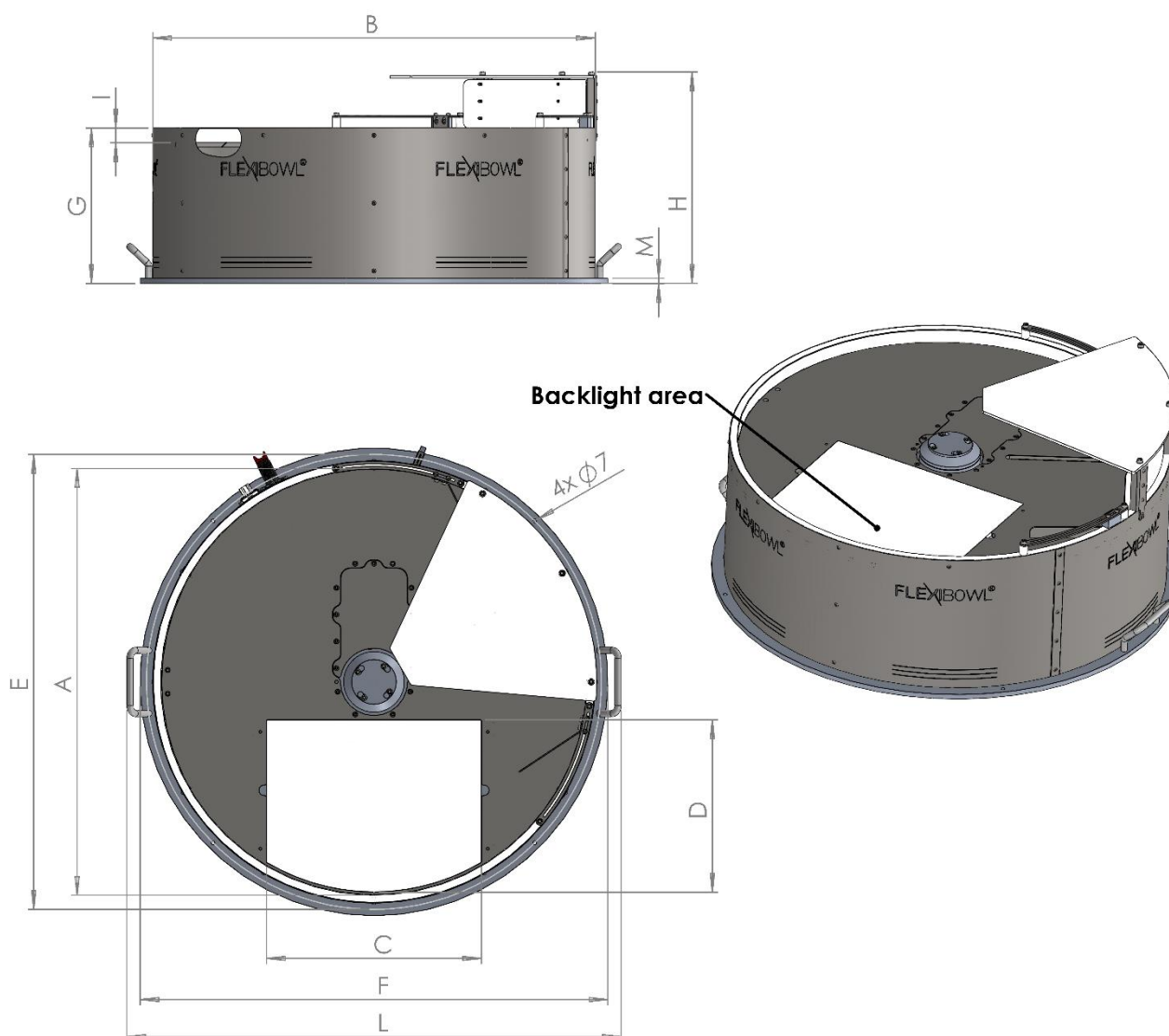

Reference	FlexiBowl® 500	FlexiBowl® 650	FlexiBowl® 800
<b>A</b>	503 mm	662 mm	810 mm
<b>B</b>	533 mm	692 mm	842 mm
<b>C</b>	334 mm	404 mm	404 mm
<b>D</b>	167 mm	250 mm	325 mm
<b>E</b>	556 mm	716 mm	866 mm
<b>F</b>	580 mm	740 mm	890 mm
<b>G</b>	296 mm	296 mm	296 mm
<b>H</b>	362 mm	362 mm	362 mm
<b>I</b>	28 mm	28 mm	28 mm
<b>L</b>	629 mm	788 mm	941 mm
<b>M</b>	10 mm	10 mm	10 mm
<b>Backlight Area</b>	51300 mm <sup>2</sup>	92200 mm <sup>2</sup>	112500 mm <sup>2</sup>

## 4.6 Main components

The machine is made up of the following essential parts:

Pos.	Item	Description
1	FRAME	
2	ROTARY DISC	In the standard version, the FlexiBowl® is supplied with a white <b>Rotary Disc</b> . It is driven by a motor inside the frame. <b>Note:</b> if there is a backlight, it must be seen through the <b>Rotary Disc</b> . The <b>Rotary Disc</b> is available in different materials and thicknesses (see the " <b>Optional Components</b> " section and attachment A: <b>FlexiBowl® Rotary Discs</b> ).
3	SLIDING SURFACE	The sliding surface supports the rotary disc. It includes a window, made of Lexan, for the optional backlight to shine through
4	FLIP UNIT	<b>FlexiBowl® 350-500-650-800</b> The Flip unit is a pneumatic cylinder that bumps the underside of the <b>Rotary Disc</b> , making the parts jump. It is located so that it flips the parts before they reach the vision window. A Flip shield, located above the disc, over the Flip unit, keeps parts from being ejected from the feeder when bumped. The frequency and duration of the bump can be programmed, depending on the type of part being fed. The bump strength can be adjusted using the air pressure regulator, located on the interface panel. <b>FlexiBowl® 200</b> The Flip unit is driven by a servo motor. Its functionality is identical to the pneumatic Flip described above.
5	FLIP SHIELD	This is mounted on the top ring over the Flip. It prevents objects from flipping over the edge.
6	MOTOR WITH DRIVER	The motor ( <b>6A</b> ) is inside the FlexiBowl® frame and moves the <b>Rotary Disc</b> . In addition to the motor, there are: driver ( <b>6B</b> ), 24Vdc power supply unit ( <b>6C</b> ) and interface card ( <b>6D</b> ).
7	COVER	This contains and protects the elements inside the FlexiBowl®. It protects the user from unnecessary exposure to electrical voltage and moving components.

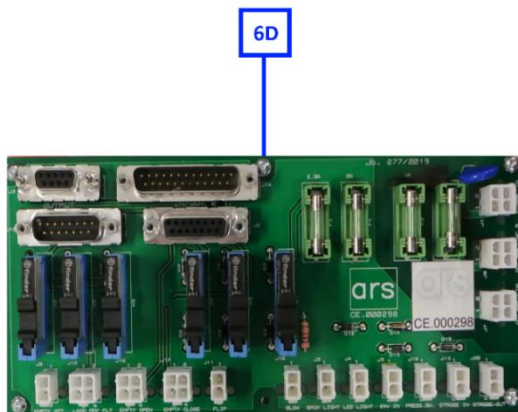
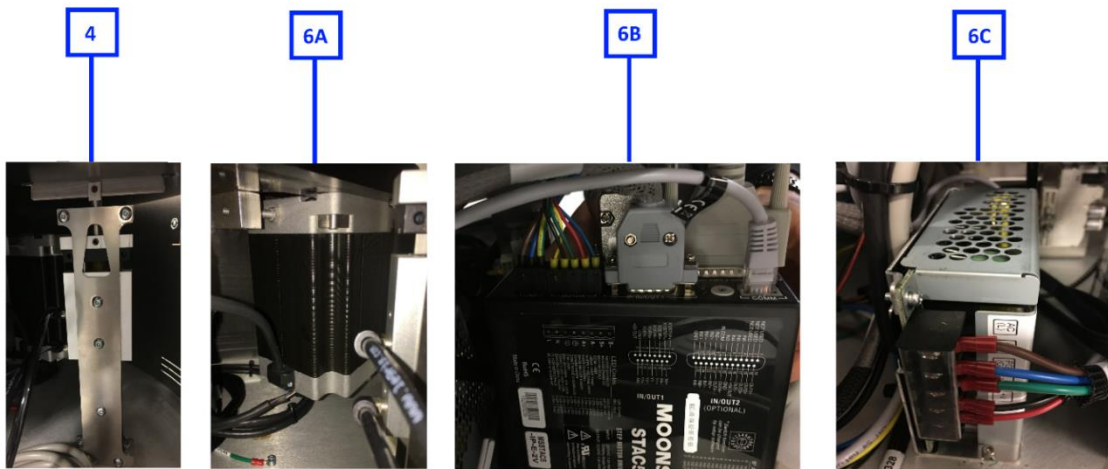
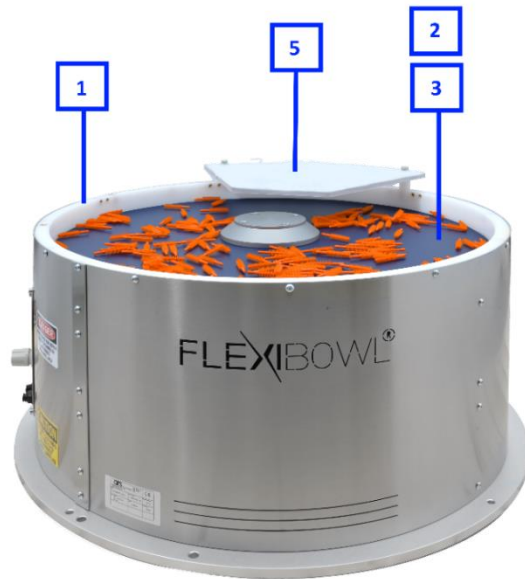

## 4.7 Optional components

The machine can be fitted with the following optional components:

Pos.	Item	Description
1	AIR BLOW	The Blow unit is to achieve a better separation of parts. It is mounted on the feeder's top ring.
2	BACKLIGHT	<p>The backlight is available in 2 models:</p> <ul style="list-style-type: none"> <li>• standard</li> <li>• strobe</li> </ul> <p>The first is constantly powered internally and it is possible to control on/off from the software or digital I/O (see <b>Chapter 6.3.3</b>).</p> <p>The second is controlled externally from the strobe input of the input connector (see <b>Chapter 5.5.1</b>). The customer is responsible for providing the suitable 24Vdc power supply to power it.</p> <p>This is a light under the vision window of the sliding surface so that its light can shine on the <b>Rotary Disc</b> and the profile of the components above becomes visible to the vision system.</p> <p>The backlight is available with the following lights:</p> <ul style="list-style-type: none"> <li>• white</li> <li>• red</li> <li>• infrared</li> </ul> <p><b>Note:</b> The infrared backlight shines an invisible light and therefore may not appear to be working. Use a camera with an infrared filter installed to check that it is working properly. Most smartphones can see infrared lights.</p>
3	QUICK EMPTYING	<p>The Quick Emptying option is used to empty residual pieces from the FlexiBowl® before a production change. The Quick Emptying option can be commanded via digital I/O or software. When a Quick Emptying command is sent, a portion of the ring lowers to let the residual pieces come out. There are two sensors to know if the Emptying Door is open or closed. It is also possible to read the status of the sensors in the input connector (see <b>Chapter 5.5.1</b>).</p> <p>The "<b>Quick Emptying</b>" sequence consists of a pre-configured sequence of combined clockwise and anticlockwise movements. In the sequence of "<b>Quick Emptying</b>" sequence, only the movement speed can be varied. It is not possible to vary the number of movements and their direction</p>
4	DIVERTER	<p>This is used to push parts away from the top ring of the FlexiBowl®, making them easier to pick by a robot. One is located before the Flip unit so that most pieces are hit by the pulse and one before the inspection window to facilitate pick-up.</p> <p><b>Note: Don't bend the diverter</b> because you could compromise the integrity of the structure it is installed on and, as a consequence, the diverter would no longer be parallel to the <b>Rotary Disc</b>. To raise or lower the diverter, loosen the screws that fix it to the block. To move the diverter forward or backward, loosen the screws you find above the guide.</p>
6	BRUSH DIVERTER	<p>It is compatible with FlexiBowl 500/650/800 ED models It has the same functions as the steel diverter. It is used in cases where workpieces tend to get stuck between the "<b>Rotary Disc</b>" and the metal diverter, this situation mainly occurs when using <b>Rotary Discs</b> with Spikes. For further information please refer to Appendix C: <b>New FlexiBowl® Options</b>.</p>

7	BRUSH DIVERTER FOR CENTRAL FLANGE	It is compatible with FlexiBowl 500/650/800 models and has the function of moving components away from the central flange to prevent them from accumulating around it. Please refer to Appendix C for more information: <b>New FlexiBowl® Options.</b>
8	BRUSH DIVERTER FOR FLIP COVER	<p>The <b>Brush Diverter for Flip Cover</b> option is compatible with FlexiBowl 500/650/800 models and has two different functions:</p> <ul style="list-style-type: none"> <li>• to contain components that are shaken by the flip unit, thus preventing them from falling out of the FlexiBowl</li> <li>• to untangle and "lie down" components that tend to tangle with each other or assume an upright position during normal FlexiBowl operation.</li> </ul> <p>Please refer to Appendix C for more information: <b>New FlexiBowl® Options.</b></p>
9	WEDGE DIVERTER	The Wedge diverter option is compatible with sizes 800/650/500 in standard version (C-CC), it is not compatible with any Edge version (200E, 350E and 500E). This option is intended to move components away from the external edge of the FlexiBowl and is particularly suitable for parts that roll or slide easily. Please refer to Appendix C for more information: <b>New FlexiBowl® Options.</b>
10	LIFT SUPPORT	It has the function of lifting custom perforated discs to handle components up to a maximum length of 100mm. Please refer to Appendix C for more information: <b>New FlexiBowl® Options.</b>
11	MULTIPLE SECTORS DISC	The " <b>Multiple sectors rotary disc</b> " option is compatible with sizes 800/650/500 in standard version (C-CC), it is not compatible with any Edge version (200E, 350E and 500E). It allows several types of components to be fed simultaneously into the same FlexiBowl. Please refer to Appendix C for more information: <b>New FlexiBowl® Options.</b>



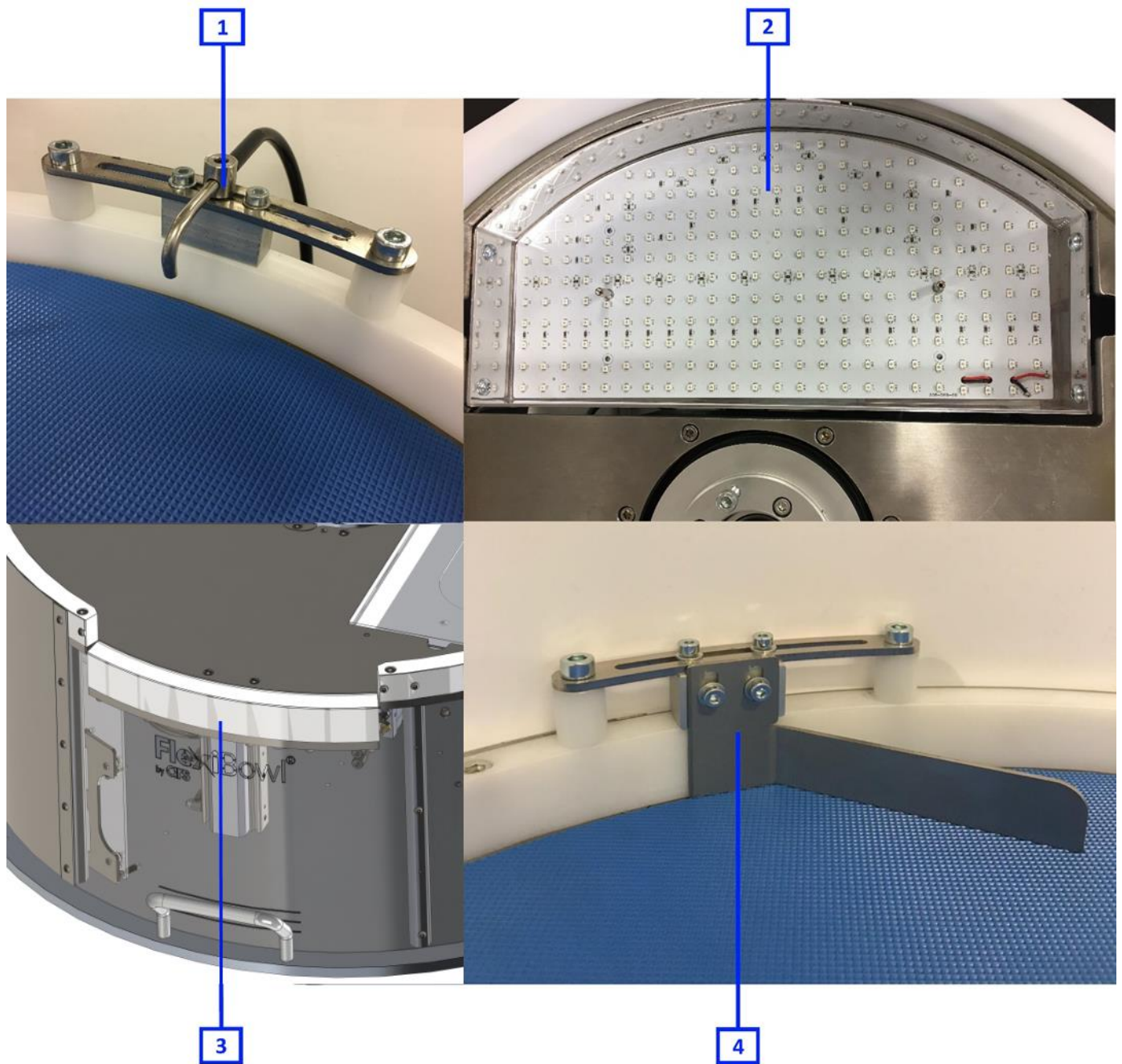



## 4.8 General description

The machine described in this manual is a rotary feeding system able to feed a wide range of loose parts in combination with any industrial robot and artificial vision system. The parts can be different shapes and materials.

**FlexiBowl®** is available in four models: **200, 350, 500, 650** and **800**. Each model is built mainly of stainless steel with anodised aluminium parts.

### 4.8.1 Processing cycle

A simplified description of the **processing cycle** is described below. The cycle is divided into the following phases:

Phases	Description
1	The operator manually places the product to be processed onto the <b>Rotary Disc</b> .
2	The machine cyclically performs rotations (set by the operator) to shake the pieces, in order to constantly ensure that they are in the pick-up position.

## 5 Transport and installation



**IMPORTANT!**

**Lifting and handling operations must only be carried out by specialised and trained staff who are qualified for these activities.**

The machine is designed to be packed, transported and assembled using a forklift truck of adequate capacity. The machine does not have any attachment points (for example, eye bolts) for lifting.

## 5.1 Packaging

The machine is shipped by **ARS S.r.l.** from the production factory to the Customer's premises.

Based on the distance to be transported, on the specific requests from the Customer, and on how long the load will remain in the packaging, the machine will be shipped in the following ways:

- normal protective packaging for short and medium distances;
- special protective packaging for long distances.

It must be shipped using closed or curtain-sided vehicles depending on the type of load.

When the machine is received, it is mandatory for the customer to check that there is no damage caused by the mode of transport or by the personnel in charge of the specific operations.

- **If any damage is discovered**, leave the packaging in question as it was found and immediately ask the competent shipping company to assess the damage; afterwards, send a damage report to inform the transport company's insurance company and the point of sale of the discovered damage.
- **If the machine is delivered in a crate on a pallet or on wooden planks** protected by heat-shrink cellophane, first remove the packaging or the cover. To completely free the machine, remove the screws and the metal strapping. Then lift the machine with a crane or forklift truck as described in the table and remove the pallet used for transport.

### 5.1.1 Table of units and weights – with packaging

Follow the table below for the weights and dimensions including packaging.

Specification	FlexiBowl® 200	FlexiBowl® 350	FlexiBowl® 500	FlexiBowl® 650	FlexiBowl® 800
<b>Gross weight (with packaging)</b>	35 Kg	42 kg	59 Kg	86 Kg	103 Kg
<b>Wooden crate dimensions (mm)</b>	700x700x500	700x700x500	700x700x500	1000x1000x500	1000x1000x500

### 5.1.2 Handling with packaging

HANDLING THE MACHINE BODY WITH PACKAGING	
Operator qualification	Lifting vehicle driver
PPE required	
Lifting vehicle	Forklift truck with capacity of at least 50 kg



**CAUTION!**

Only use suitable and approved lifting vehicles; compatible with the dimensions and weight of the machine.



**CAUTION!**

Make sure that no one is standing under or within the operating range of the lifting vehicle.

Proceed as described to **handle the machine body with packaging**:

Step	Action
1	Put the forks of the forklift truck under the wooden crate containing the machine.
2	Make sure the forks come out of the front of the load (by at least 5 cm), far enough to eliminate any risk of the transported part from overturning.
3	Lift the forks until they touch the load. <b>Note:</b> if necessary, fasten the load to the forks with clamps or similar devices.
4	Slowly lift the load ten centimetres or so off the floor and check its stability, making sure that the centre of the load is in the middle of the lifting forks.
5	Tilt the mast backwards (towards the driver's seat) to use the tilting moment to ensure greater stability of the load during transport.
6	Adjust the transport speed according to the floor and type of load, avoiding sudden manoeuvres.



**CAUTION!**

Place the forklift truck forks as shown in the figure

### 5.1.3 Removing the packaging

Proceed as follows to **remove the packaging**:

Step	Action
1	Put the machine in its intended place.
2	Unscrew the FlexiBowl® from the base of the wooden crate used for shipping.
3	Take the USB device and the test file out of the crate. Keep them for future use.
4	Use the side handles on the FlexiBowl® to lift it out of the crate.



**CAUTION!**

**2 operators are needed to manually lift the FlexiBowl® out of the wooden crate.**

To handle the machine and/or its parts, see the “**Transport and handling**” section.

### 5.1.4 Disposing of the packaging

The packaging is an integral part of the supply and is not collected, hence it must be disposed of by the buyer.

Any disposal or destruction must be carried out in compliance with the regulations in force in the user's country, taking into account the nature of the materials:

- wood for the crates;
- plastic sheet to protect the machine and adhesive tape to secure the plastic;
- moisture absorber sachets;
- etc.

## 5.2 Transport and handling

**ARS s.r.l.** uses packaging and fasteners according to the mode of transport to guarantee integrity and conservation during transport.

When the machine is received, make sure no part was damaged during transport and/or handling.

**If damage is found, it is mandatory to immediately inform the Manufacturer.**

The handling activities described in this section must be carried out by personnel who are qualified for these operations: personnel duly trained to safely perform the loading, unloading and handling operations with lifting equipment, and who are aware of the accident prevention rules.



**CAUTION!**

**ARS S.r.l. shall not be held liable for damage, to property or to people, due to accidents caused by failure to follow the instructions in this manual.**

### 5.2.1 Table of units and weights

After unpacking the machine, it is already fully assembled.

Follow the table below for the weights and dimensions of the various models.

Model	Weight	Maximum dimensions
<b>FlexiBowl® 200</b>	18 Kg	470 x 254 x 319 mm
<b>FlexiBowl® 350</b>	25 Kg	447 x 404 x 368 mm
<b>FlexiBowl® 500</b>	42 Kg	629 x 580 x 362 mm
<b>FlexiBowl® 650</b>	54 Kg	788 x 740 x 362 mm
<b>FlexiBowl® 800</b>	71 Kg	941 x 890 x 362 mm



## 5.4 Installation

### 5.4.1 Preparations by the customer

Notwithstanding any different contractual agreements, preparation of the following **is usually the responsibility of the Customer**:

- **rooms** (including masonry, such as foundations or ducts that may be required, lighting);
- **electrical systems** up to the machine's power points, in compliance with the regulations in force in the country of installation and/or requested by the machine Manufacturer. All technical specifications requested by the Manufacturer are in the sales contract. The Manufacturer disclaims all liability if the customer fails to guarantee the technical specifications of the electrical system required in the sales contract.
- **the power supply for the machine**, including the earthing conductor, according to the characteristics and tolerances requested and specified in this manual.
- auxiliary services adapted to the machine's requirements;
- **tools and consumables** required for assembly and installation;
- **lubricants** necessary for starting the machine;
- the **compressed air supply** for the machine adjusted as specified in the "Technical specifications" section;
- suitable lifting and handling means.

### 5.4.2 Permitted environmental conditions

The environment where the machine will be installed and used is indoors, protected from atmospheric agents such as: rain, hail, snow, fog, suspended dust, combustible dust, protected from aggressive agents such as corrosive vapours or sources of excessive heat and it must not be ATEX classified.

It is not permitted to use the machine, associated control systems and drive equipment under conditions other than those listed.

Namely, the environment of installation and use must not be:

- Exposed to corrosive fumes;
- Exposed to excessive humidity (above 85%) and rapid changes in relative humidity (above 0.005 p.u./h);
- Exposed to excessive dust;
- Exposed to abrasive dust;
- Exposed to oily vapours;
- Exposed to explosive mixtures of dust or gas;
- Exposed to salty air;
- Exposed to abnormal vibrations, impact or shock;
- Exposed to adverse weather outside the permitted range or dripping;
- Exposed to unusual transport or storage conditions;
- Exposed to high or quick temperature variations (above 5K/h);
- In the presence of nuclear radiation.

The machine is designed and built to work safely in the following environmental conditions:

Permitted environmental conditions	
Environmental temperature	5 - 40°C
Humidity range	5 - 90% (without condensation)
Environmental lighting	Neon lights



#### CAUTION!

**Different environmental conditions to those specified can cause serious damage to the machine.**

**Positioning the machine in environments not observing the above will void the warranty for the parts to be replaced.**



#### IMPORTANT!

**The work surface must be sufficiently lit. If there are shady or uneven zones in the workplace, it is up to the user to provide suitable lighting devices.**

If these requirements are not met, the Manufacturer disclaims all liability.

### 5.4.3 Installation site

For installation, prepare an area suitable for the dimensions of the machine and lifting vehicles, paying attention to any obstacles (other machines, walls or similar) along the path of the handling vehicles.

### 5.4.4 Machine position

Step	Action
1	Place the FlexiBowl® on a stable surface. <b>Note:</b> if the FlexiBowl® is installed on a machine platform (sensitive to vibrations), put some insulating and vibration damping material between the platform and the FlexiBowl®.
2	Fix the FlexiBowl® through the holes. <b>Note:</b> the FlexiBowl® has 4 holes for M6 screws on its base so that it can be fixed to a surface.
3	Connect as necessary (see the “ <b>Connections</b> ” section).

**CAUTION!**

Leave a space of approximately 100mm for the power supply connectors of the FlexiBowl®

**CAUTION!**

Make sure the machine support surface is flat and horizontal and can withstand its weight.

## 5.6 Connections

To start the machine, it must be properly connected to the local networks:

- **electrical connection** (including connection to the earthing system),
- **compressed air connection**, in compliance with the regulations in force in the country of installation.

It might also be necessary to connect the machine to the **LAN**.

It is the user's responsibility to guarantee the requested connection characteristics.



**CAUTION!**

**The required connections must be set up by qualified and authorised personnel.**

## 5.7 Electrical connection



**CAUTION!**

**Before doing any electrical connections, it is important to ensure that the machine is turned off.**



**CAUTION!**

**Make sure the customer's power supply has already been disconnected.**

The buyer is responsible for compliance of the connection between the machine and the earthing system.



**CAUTION!**

**The operation must only be carried out by specialised and authorised personnel (electrical maintenance technician).**

Before proceeding with the **electrical connection**, ensure that:

- the maintenance technician is fully aware of the regulations in force in the country of installation;
- the frequency and supply voltage values of the machine match the mains values;
- the cross-section of the electric cables is adequate for the power consumption;
- the power line can withstand the maximum machine power consumptions;
- earthing of the circuit complies with **EN 60204-1**;
- the materials used in the earthing system have adequate strength or adequate mechanical protection.



**CAUTION!**

**Do not work with wet hands or objects. In case of fire, do not use water on the electrical components.**

**ELECTRICAL CONNECTION – AC**

<b>Operator qualification</b>	Electrical maintenance technician
<b>PPE required</b>	

Proceed as described below for **connection to the mains – AC**:

<b>Step</b>	<b>Action</b>
<b>1</b>	Connect the system to the power supply. <b>Note:</b> the power cable is not supplied by <b>ARS s.r.l.</b>
<b>2</b>	Make sure the earthing system is installed correctly.

**IMPORTANT!**

The power supply range is 110 – 220 VAC +/-5%. **CAUTION!**

**CAUTION!**

An incorrect power supply can cause problems to the system and stop it from working properly.

### 5.7.1 Input pinout

The table below lists the functions of each contact of the **Input connector (Sub-Din 25M)**:

Pin	Signal	Picture
1	Move	
2	Move-Flip	
3	Move-Flip-Blow	
4	Move-Blow	
5	Shake	
6	Backlight ON	
7	Backlight OFF	
8	Flip	
9	Reset Alarm	
10	Quick Emptying	
11	Emptying Door open (Read-only)	
12	Emptying Door closed (Read-only)	
13	24Vdc out	
14	24Vdc common	
15	24Vdc out	
16	Strobe Backlight +	
17	Strobe Backlight -	
18	A+ Encoder (Read-only and with <b>FlexiTrack</b> option)	
19	A- Encoder (Read-only and with <b>FlexiTrack</b> option)	
20	B+ Encoder (Read-only and with <b>FlexiTrack</b> option)	
21	B- Encoder (Read-only and with <b>FlexiTrack</b> option)	
22	Z+ Encoder (Read-only and with <b>FlexiTrack</b> option)	
23	Z- Encoder (Read-only and with <b>FlexiTrack</b> option)	
24	GND Encoder (Read-only and with <b>FlexiTrack</b> option)	

**Note:** If the strobe light is purchased, it is the customer's responsibility to provide correct 24Vdc power supply to Pin 16 and 17.

**Note:** If the **FlexiTrack** option was required, refer to the input pinout table to connect to the FlexiBowl® encoder. The encoder is a 2 channel quadrature TTL squarewave outputs with a resolution of 1000 CPR.

Below is an example of an **input connection**:

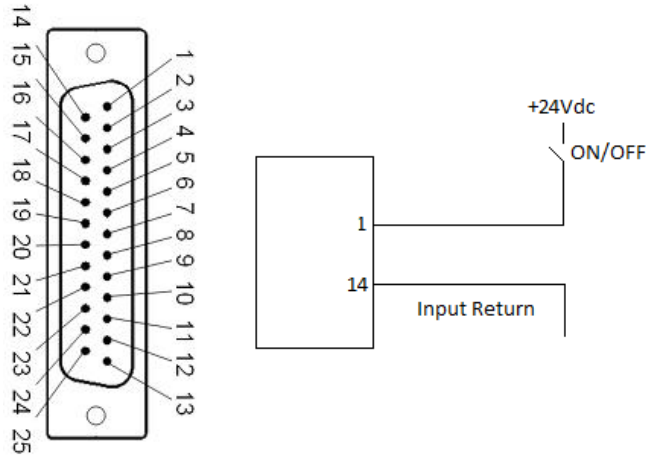

Input electrical specifications	
<b>power supply range</b>	0 - 24 VDC
<b>OFF status range</b>	<1 VDC
<b>ON status range</b>	12 - 24 VDC
<b>current range</b>	0 - 9 mA
<b>ON status current range</b>	2 - 9 mA

### 5.7.2 Output pinout

The table below lists the functions of each contact of the **Output connector (DE9F)**:

Pin	Signal	Picture
1	Busy +	
2	Ready +	
3	Fault +	
5	Common	
4,6,7,8,9	-	

Below is an example of an **output connection**:

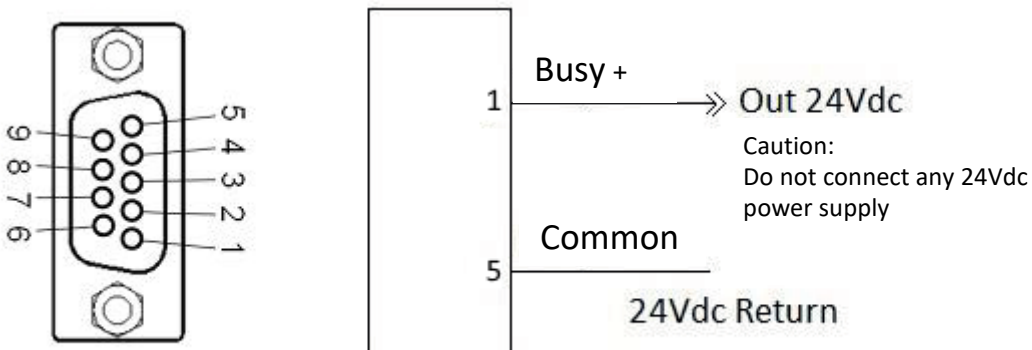

Output electrical specifications	
<b>Output power supply</b>	0-24 VDC

<b>Output current</b>	$I_{out} \leq 250 \text{ mA}$
-----------------------	-------------------------------

### 5.7.3 Compressed air connection

The machine has a pneumatic drive.

Before setting up the **compressed air connection**, ensure that:

- the compressed air supply system guarantees the right amount of air to the machine at the right pressure;
- the compressed air tank provided is properly sized.

The compressed air connection must be set up by connecting the main line to the machine circuit.

The customer must also guarantee an air supply with the characteristics listed in the “Technical Specifications” section in this manual.



**CAUTION!**

**Never exceed a pressure of 6 bar in the machine’s compressed air system.**



**CAUTION!**

**It is the responsibility of the user/customer to ensure that the main air handling unit is connected properly with rigid pipes, firmly fixed to prevent a whip effect or protected with other guards that prevent or block “jet” leaks.**

Compressed air connection	
<b>Operator qualification</b>	Mechanical maintenance technician
<b>PPE required</b>	

Proceed as described below for connection to the compressed air line:

Step	Action	Picture
1	<p>Connect a Ø6 mm air pipe to the “Air Supply” socket in the control panel (as shown in the picture). The exact air pressure is indicated on the display above the pressure regulator.</p> <p><b>Note:</b> make sure there is a shut-off valve between the room air supply and the FlexiBowl®.</p>	

### 5.7.4 Other connections

#### 5.7.4.1 Air Blow connection (optional)

If the optional Air Blow component is present, connect as follows:

Step	Action	Picture
1	Connect a Ø6 mm air pipe from the "Air Blow" socket in the control panel to the Air Blow unit.	

#### 5.7.4.2 Mapping of connections between the control devices

The FlexiBowl® is supplied already wired. If necessary, below is a map of the connections between the control devices.

Pos.	Item
1	I/O INTERFACE CONNECTOR
2	I/O INTERFACE CONNECTOR
3	ETHERNET CONNECTION
4	ENCODER CONNECTOR
5	VAC POWER SUPPLY CONNECTOR
6	MOTOR POWER SUPPLY CONNECTOR

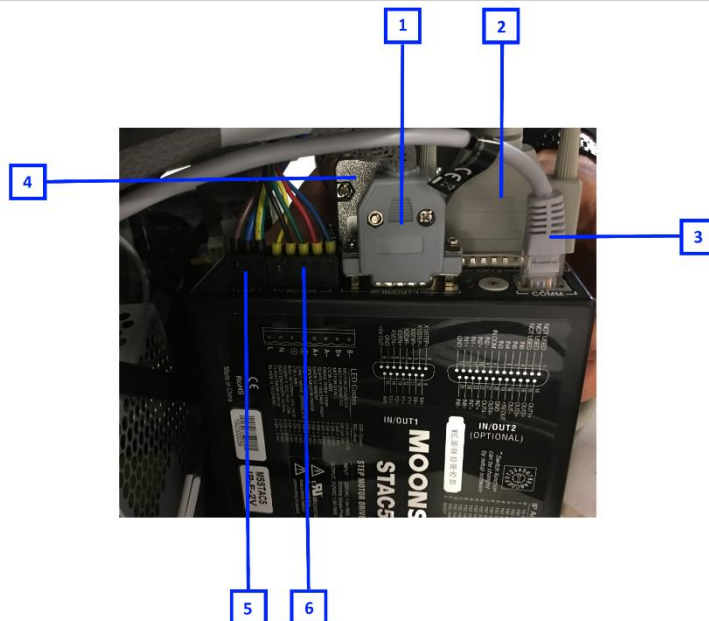



### 5.7.4.3 Connecting the user interface

Proceed as described below to connect the user interface:

Step	Action	Picture
1	Connect the user interface to the Ethernet socket with an Ethernet cable.	

## 6 Controls and use

During operation, the machine does not need to be continuously manned by an operator.



**CAUTION!**

**Using the machine for a purpose other than intended by the Manufacturer can cause serious damage to people and/or property and/or animals.**

**ARS S.r.l. shall not be held liable for damage caused by machine misuse.**

## 6.1 Description of the control panel

Pos.	Item	Connector	Notes
1	OUTPUTS CONNECTOR	DE9F	
2	INPUTS CONNECTOR	DE25M	
3	PRESSURE INDICATOR	-	
4	ETHERNET PORT	802.3	
5	PRESSURE REGULATOR	-	The pressure regulator controls the strength with which the Flip unit bumps the underside of the rotating disc, to flip the parts over. <b>Note:</b> The pressure regulator does not control the pressure of the Air Blow unit, if present. <b>Note:</b> The pressure is indicated on the display (3)
6	AC SWITCH	-	
7	STATUS LED	-	
8	BACKLIGHT STATUS LED	-	
9	COMPRESSED AIR CONNECTION	6 mm	
10	AIR CONNECTION FOR THE AIR BLOW UNIT	6 mm	
11	POWER SUPPLY CONNECTOR 110 - 220 VAC +/-5%		

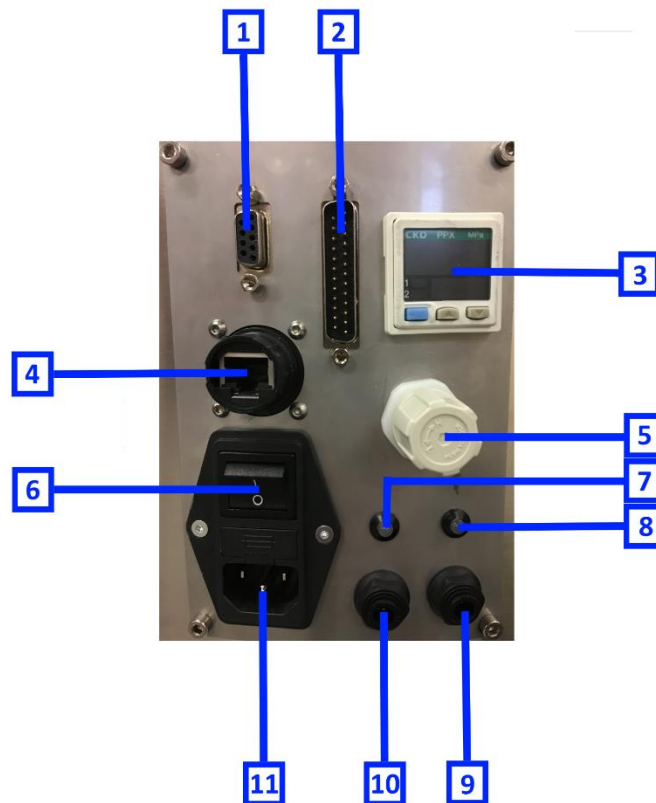

## 6.2 User interface - FlexiBowl® Parameters

The FlexiBowl Parameters program is used to set the movement parameters and the option parameters available. The various parameters can only be changed via Ethernet communication.

### 6.2.1 Installing and using the FlexiBowl® Parameters program

Proceed as described below to **use the program**:

Step	Action	Picture
1	Use the program supplied on the USB. <b>Note:</b> if you have an older version of the program it must be uninstalled first.	
2	Connect the FlexiBowl® with an Ethernet cable.	
3	Turn the device on.	
4	Run the program.	
4	For the connection of the FlexiBowl®, enter the following network address in the "Ip Address" box: 192.168.1.10. The IP address of the connected PC must necessarily be set in the same subnet mask in Class B (Subnet Mask 255.255.0.0). You can now connect to the FlexiBowl®. First press Ping (a pop-up with " <b>FlexiBowl® found</b> " will be displayed). Press " <b>ok</b> " to enable the button " <b>CONNECT</b> " for connection.	
6	After connecting, the home screen will be displayed.	

### 6.2.2 Change IP address

The “Change IP” button allows you to change the IP address.

**Note:** you are not allowed to change the subnet mask.

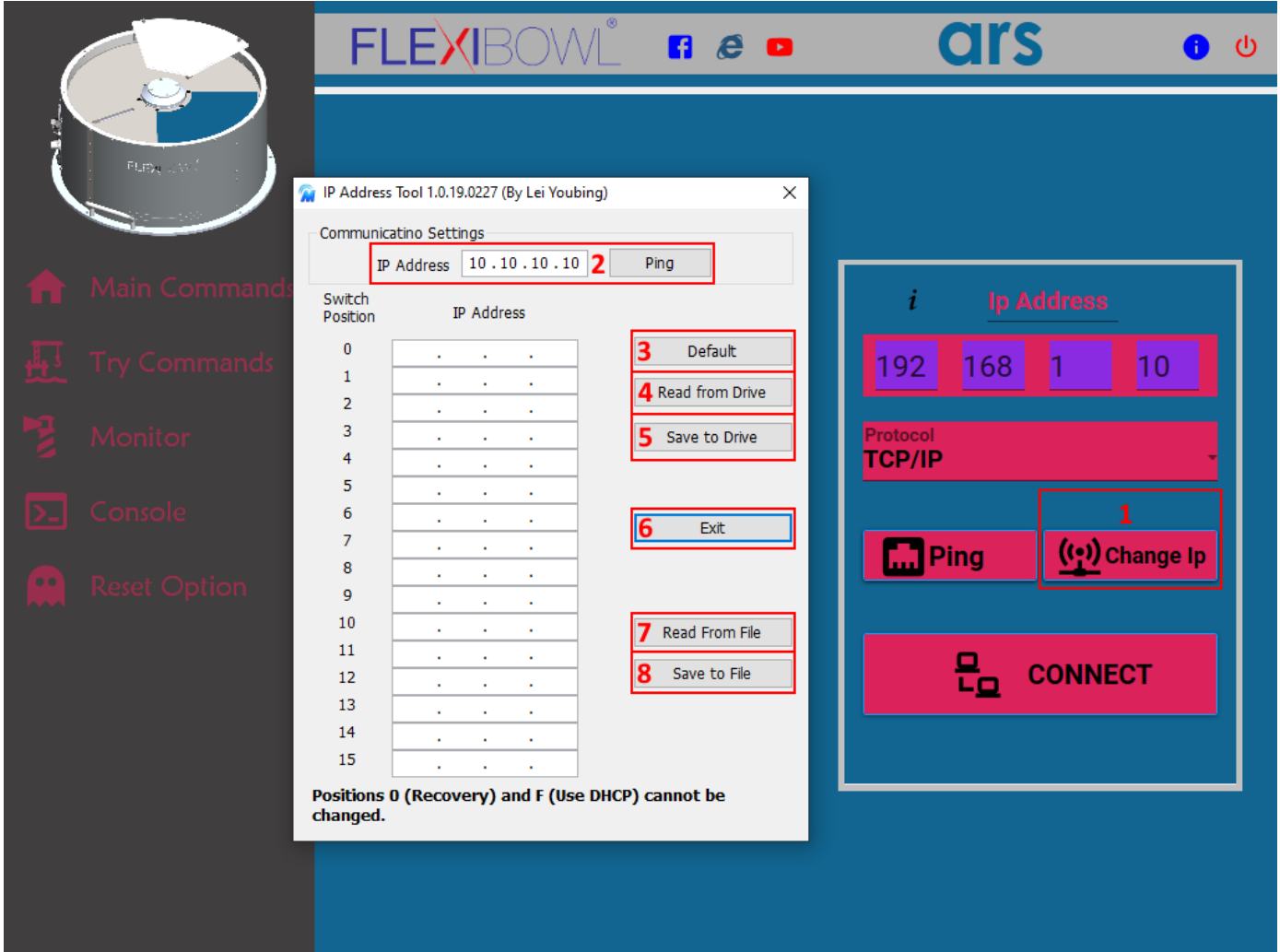

Pos.	Item	Description
1	Change IP	It opens the pop-up window to change the IP address
2	Ping	It pings the FlexiBowl® with the IP address inserted
3	Default	It inserts in the pop-up table the default FlexiBowl® IP addresses
4	Read from Drive	It reads the currently set IP addresses
5	Save to Drive	It saves the currently set IP addresses
6	Exit	It closes the window
7	Read from file	It reads the file with the IP addresses if previously generated by pressing Save to File
8	Save to File	It generates a file containing the current table of IP addresses

**Note:** restart the FlexiBowl® to apply the changes

**Note:** the IP addresses corresponding to position 0 and F cannot be modified.

### 6.2.3 IP address recovery

If the IP address is lost, you can use the driver's rotary dip switch to interface again with the FlexiBowl®. See picture below:

#### IP Address\*

- 0 10.10.10.10
- 1 192.168.1.10
- 2 192.168.1.20
- 3 192.168.1.30
- 4 192.168.0.40
- 5 192.168.0.50
- 6 192.168.0.60
- 7 192.168.0.70
- 8 192.168.0.80
- 9 192.168.0.90
- A 192.168.0.100
- B 192.168.0.110
- C 192.168.0.120
- D 192.168.0.130
- E 192.168.0.140
- F DHCP





**CAUTION! Disconnect the power supply before performing the following procedure**

For the **FlexiBowl® 200** and **350**, follow the instructions below to place the dip switch in a different position from the current one:

Step	Action	Picture
1	Unplug the power cable in the control panel	
2	Remove the FlexiBowl® covers	
3	Identify the driver	
4	Use a flat screwdriver to select the position of the correct dip switch	<p><b>IP Address*</b></p> <ul style="list-style-type: none"> <li>0 10.10.10.10</li> <li>1 192.168.1.10</li> <li>2 192.168.1.20</li> <li>3 192.168.1.30</li> <li>4 192.168.0.40</li> <li>5 192.168.0.50</li> <li>6 192.168.0.60</li> <li>7 192.168.0.70</li> <li>8 192.168.0.80</li> <li>9 192.168.0.90</li> <li>A 192.168.0.100</li> <li>B 192.168.0.110</li> <li>C 192.168.0.120</li> <li>D 192.168.0.130</li> <li>E 192.168.0.140</li> <li>F DHCP</li> </ul>
5	Reassemble all components	

For the **FlexiBowl® 500, 650** and **800**, follow the instructions below to place the dip switch in a different position from the current one:

Step	Action	Picture																																
1	Unplug the power cable in the control panel																																	
2	follow the procedure described in <b>Chapter 7.3.1 (replacing the backlight)</b> up to point 4																																	
3	Use a flat screwdriver to select the position of the correct dip switch	<p data-bbox="973 667 1189 701"><b>IP Address*</b></p> <table data-bbox="973 712 1189 1070"> <tr><td>0</td><td>10.10.10.10</td></tr> <tr><td>1</td><td>192.168.1.10</td></tr> <tr><td>2</td><td>192.168.1.20</td></tr> <tr><td>3</td><td>192.168.1.30</td></tr> <tr><td>4</td><td>192.168.0.40</td></tr> <tr><td>5</td><td>192.168.0.50</td></tr> <tr><td>6</td><td>192.168.0.60</td></tr> <tr><td>7</td><td>192.168.0.70</td></tr> <tr><td>8</td><td>192.168.0.80</td></tr> <tr><td>9</td><td>192.168.0.90</td></tr> <tr><td>A</td><td>192.168.0.100</td></tr> <tr><td>B</td><td>192.168.0.110</td></tr> <tr><td>C</td><td>192.168.0.120</td></tr> <tr><td>D</td><td>192.168.0.130</td></tr> <tr><td>E</td><td>192.168.0.140</td></tr> <tr><td>F</td><td>DHCP</td></tr> </table> 	0	10.10.10.10	1	192.168.1.10	2	192.168.1.20	3	192.168.1.30	4	192.168.0.40	5	192.168.0.50	6	192.168.0.60	7	192.168.0.70	8	192.168.0.80	9	192.168.0.90	A	192.168.0.100	B	192.168.0.110	C	192.168.0.120	D	192.168.0.130	E	192.168.0.140	F	DHCP
0	10.10.10.10																																	
1	192.168.1.10																																	
2	192.168.1.20																																	
3	192.168.1.30																																	
4	192.168.0.40																																	
5	192.168.0.50																																	
6	192.168.0.60																																	
7	192.168.0.70																																	
8	192.168.0.80																																	
9	192.168.0.90																																	
A	192.168.0.100																																	
B	192.168.0.110																																	
C	192.168.0.120																																	
D	192.168.0.130																																	
E	192.168.0.140																																	
F	DHCP																																	
5	Reassemble all components																																	

## 6.2.4 Home screen



Pos.	Item	Description
1	Main Commands	It shows the main window for all movements and parameters associated with FlexiBowl®
2	Try Commands	It opens a window to try a sequence of several combined movements.
3	Monitor	It opens a window to monitor the I/O statuses of the FlexiBowl®, the status of the driver and any list of errors.
4	Console	It opens a window to send command strings to the driver.
5	Reset Option	It opens a window to reset the FlexiBowl® at Factory status (only the parameters not the IP Address) and command the Emptying Door manually



6.2.4.1 Move

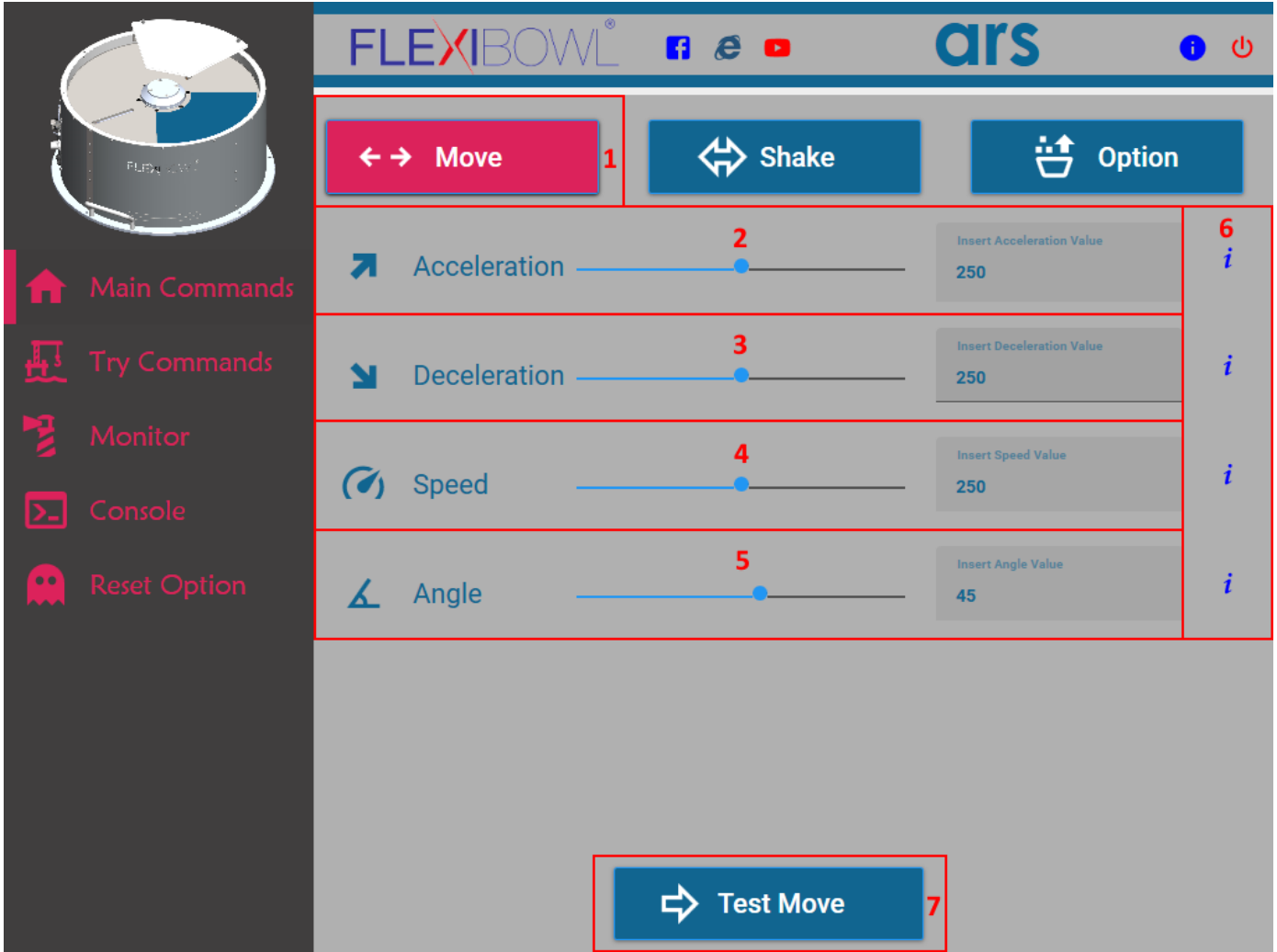

Pos.	Item	Description
1	Move	It shows the window to set the Move parameters. <b>Note:</b> to execute the movement command, press the <b>Test Move</b> button.
2	Acceleration	Acceleration used for each subsequent Move command.
3	Deceleration	Deceleration used for each subsequent Move command.
4	Speed	Speed, in RPM, at which the FlexiBowl® will advance at each subsequent Move command.
5	Angle	Angle by which the FlexiBowl® will advance at each subsequent Move command.
6	Information	Information regarding the parameter.
7	Test Move	It performs the Move command with the selected parameters.

## 6.2.4.2 Shake

The screenshot shows the FLEXIBOWL control interface. On the left is a sidebar with navigation icons and labels: Main Commands, Try Commands, Monitor, Console, and Reset Option. The main interface has a top bar with the FLEXIBOWL logo, social media icons, and the 'ars' logo. Below this are three buttons: 'Move', 'Shake' (highlighted in pink), and 'Option'. The 'Shake' button is labeled with a red '1'. The 'Shake' command settings are displayed in a list with sliders and input fields:

- 2** Acceleration: slider set to 250, input field 'Insert Acceleration Value' with '250'. Information icon **8**.
- 3** Deceleration: slider set to 250, input field 'Insert Deceleration Value' with '250'. Information icon **i**.
- 4** Speed: slider set to 250, input field 'Insert Speed Value' with '250'. Information icon **i**.
- 5** CCW Angle: slider set to -45, input field 'Insert CCw Angle Value' with '-45'. Information icon **i**.
- 6** CW Angle: slider set to 45, input field 'Insert Cw Angle Value' with '45'. Information icon **i**.
- 7** Count: slider set to 1, input field 'Insert Count Shake' with '1'. Information icon **i**.

At the bottom of the settings area is a blue 'Test Shake' button labeled with a red '9'.

Pos.	Item	Description
1	Shake	It shows the window to set the Shake command parameters. <b>Note:</b> to execute the movement command, press the <b>Test Shake</b> button
2	Acceleration	Acceleration used for each subsequent Shake command.
3	Deceleration	Deceleration used for each subsequent Shake command.
4	Speed	Speed, in RPM, at which to shake the FlexiBowl® at each subsequent shake command.
5	CCW Angle	Counterclockwise angle the FlexiBowl® moves for each shake at subsequent shake command.
6	CW Angle	Clockwise angle the FlexiBowl® moves for each shake at subsequent shake command.
7	Count	Number of Shake command. <b>Example:</b> sh_count=3 means that the FlexiBowl® will move counterclockwise at an angle of ccw_angle, clockwise at an angle of cw_angle, repeated 3 times.
8	Information	Information regarding the parameter.
9	Test Shake	It performs the Shake movement with the selected parameters.

6.2.4.3 Option

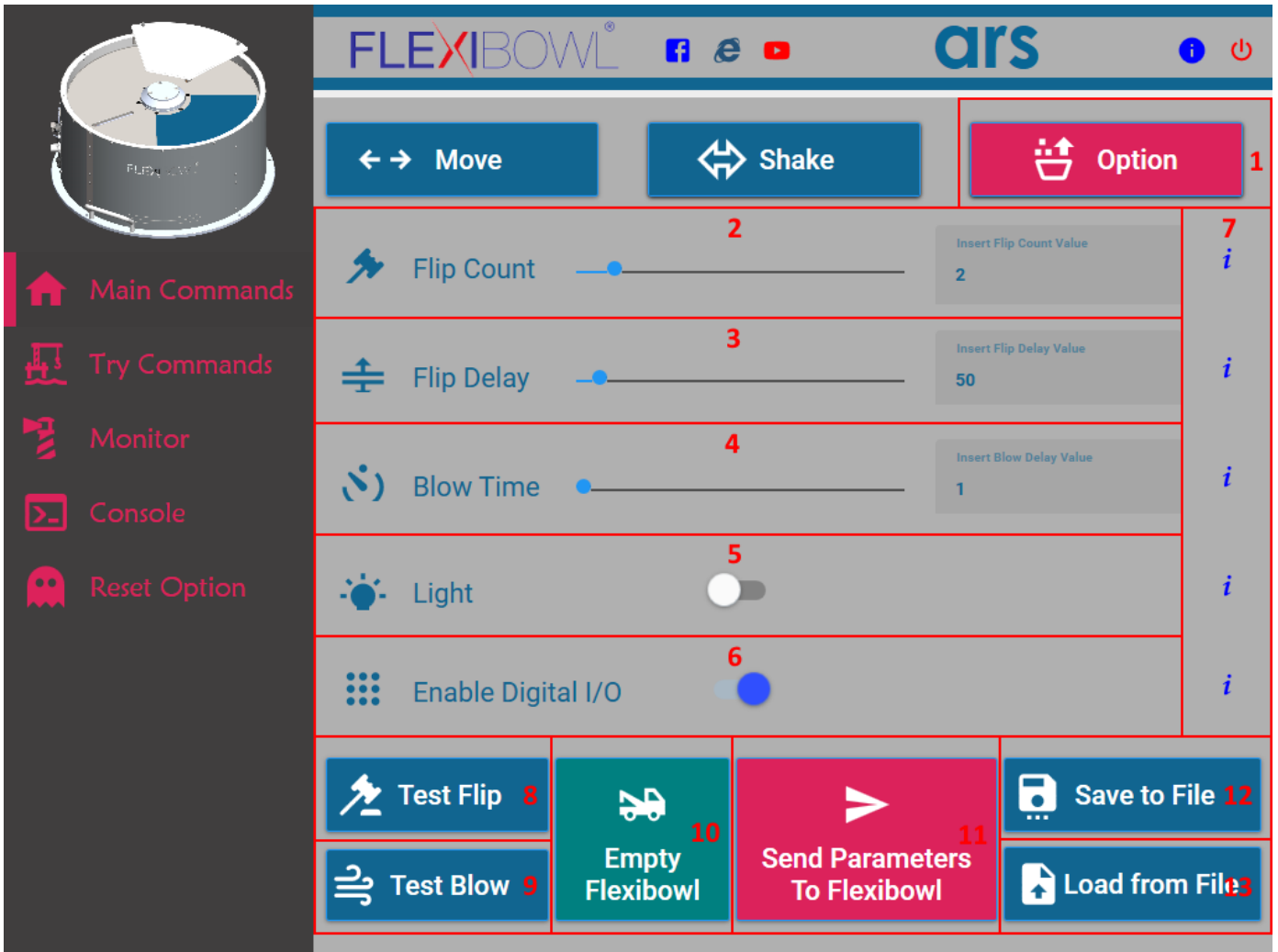

Pos.	Item	Description
1	Option	It shows the main window regarding the FlexiBowl® general options (Flip, Blow, Backlight, etc.)
2	Flip Count	Number of ON/OFF cycles that the Flip will perform at each subsequent Flip command.
3	Flip Delay	Time, in milliseconds, between an ON and an OFF of the Flip at each subsequent Flip command.
4	Blow Time	Air Blow time, in milliseconds.
5	Light	Turn the backlight on/off.
6	Enable Digital I/O	Enable the option to command the FlexiBowl® via I/O. <b>Note:</b> The FlexiBowl® must be restarted to apply.
7	Test Flip	It performs a Flip command with the selected parameters.
8	Test Blow	It performs an Air Blow command with the selected parameters.
8	Information	Information regarding the parameter.
10	Send Parameters To FlexiBowl®	It saves the command parameters set in the FlexiBowl® user interface.
11	Save To File	It saves the command parameters set in the FlexiBowl® user interface in a file.
12	Load From File	It loads the command parameters from a previously saved file.

## 6.2.5 Try Commands

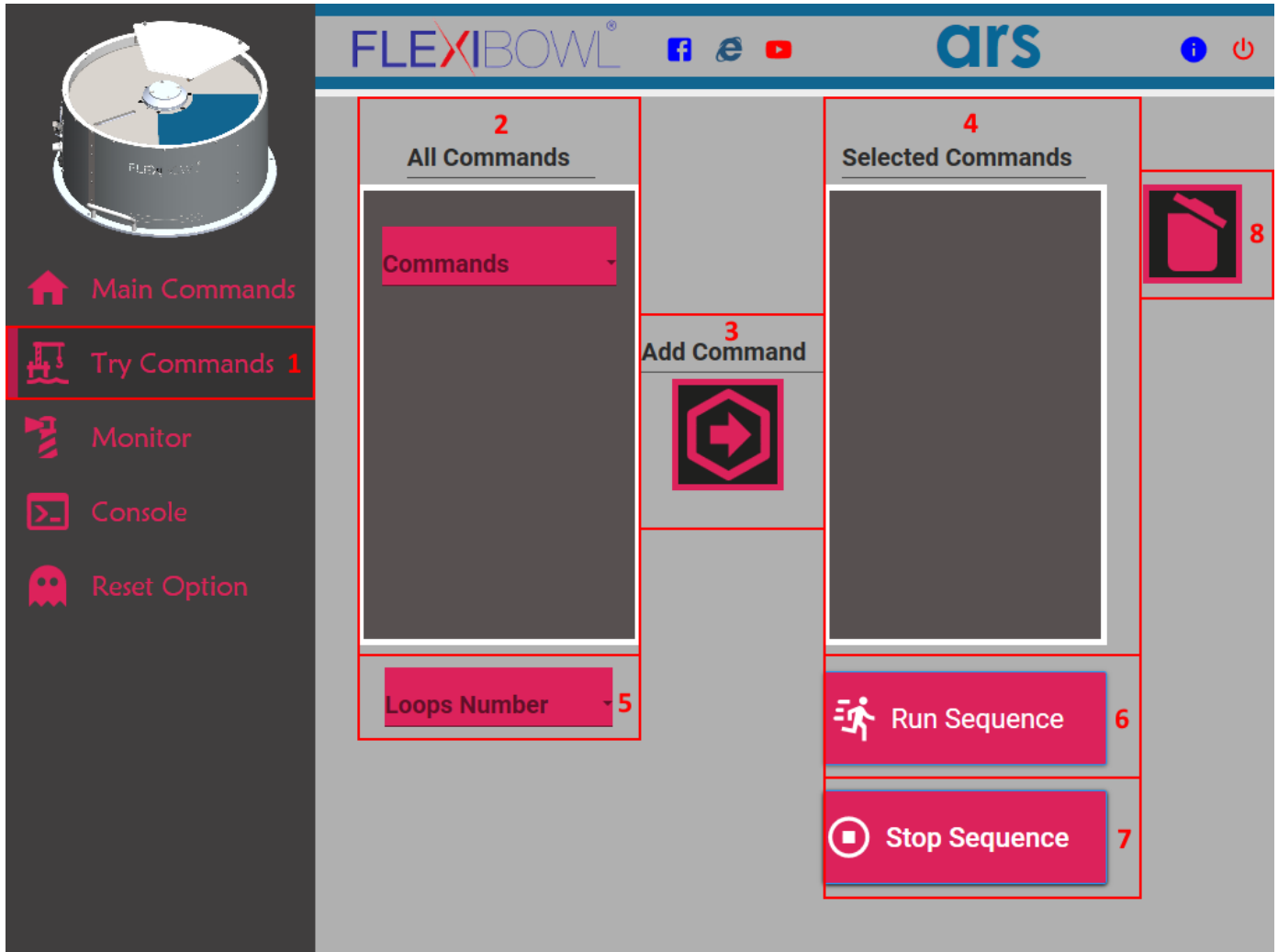

Pos.	Item	Description
1	Try Commands	It shows the windows to try a sequence of commands.
2	All Commands	It is used to select the available commands.
3	Add command	It is used to enter the command selected in the work sequence.
4	Selected Commands	List of commands added to the work sequence.
5	Loops Number	It is used to set the number of loops for the commands to be performed.
6	Run Sequence	It performs the created sequence.
7	Stop Sequence	It stops the current sequence.
8	Delete Command	It deletes the selected command from the sequence.

**Note:** To use the parameters set in the previous command windows, you must first save them inside the FlexiBowl®. This can be done in the Option window by pressing the Send Parameters to FlexiBowl® button.

### 6.2.6 Monitor

In the Monitor window is possible to check the FlexiBowl® status and eventually if are present some alarms.

#### 6.2.6.1 I/O Status

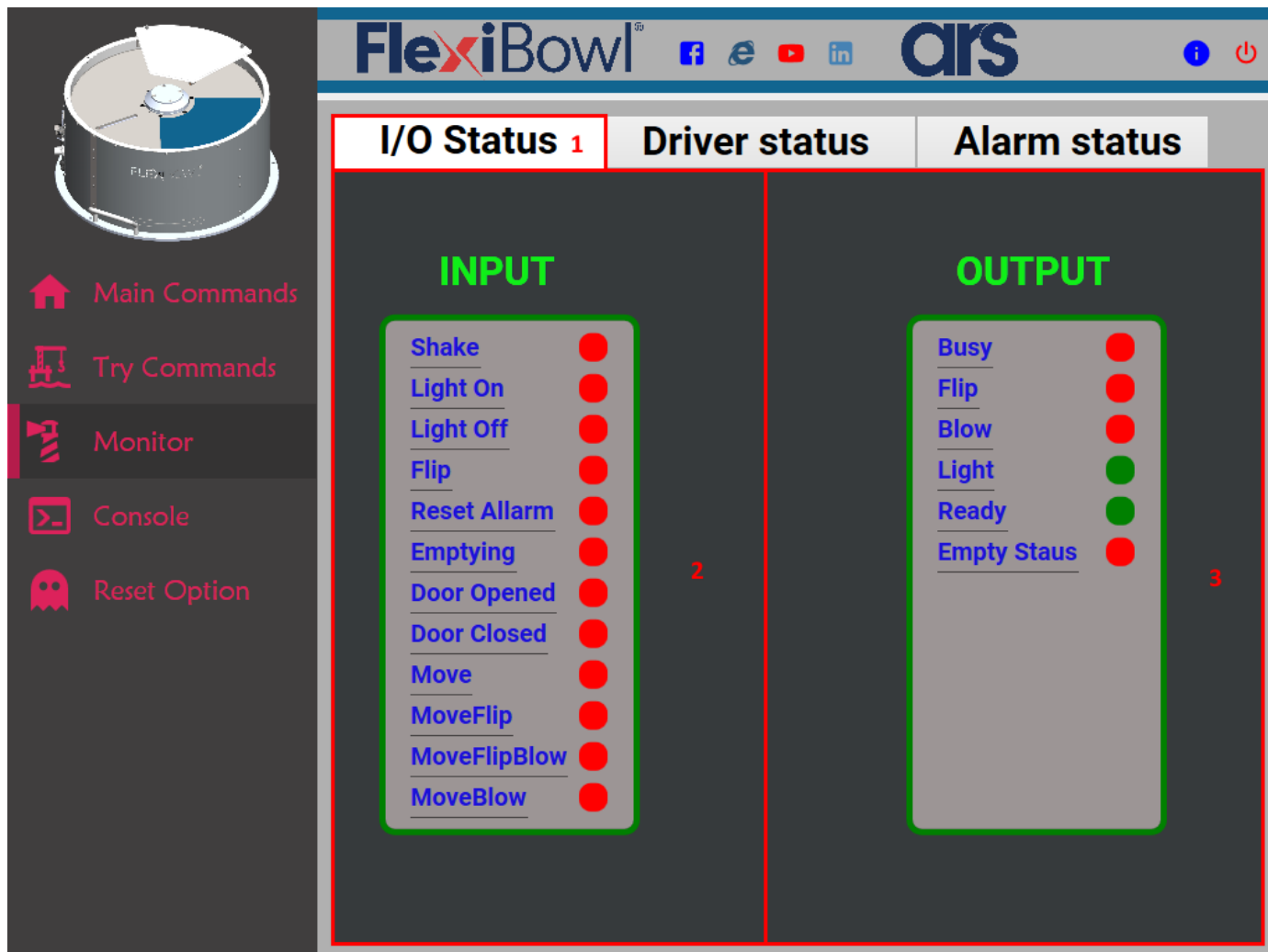

Pos.	Item	Description
1	I/O Status	View the inputs and outputs status
2	Input status	It shows the input status in the FlexiBowl®
3	Output status	It shows the output status in the FlexiBowl® <b>Note:</b> it's not possible to change the output status

6.2.6.2 Driver Status

Pos.	Elemento	Descrizione
1	Driver Status	It shows the FlexiBowl® status

6.2.6.3 Alarm Status

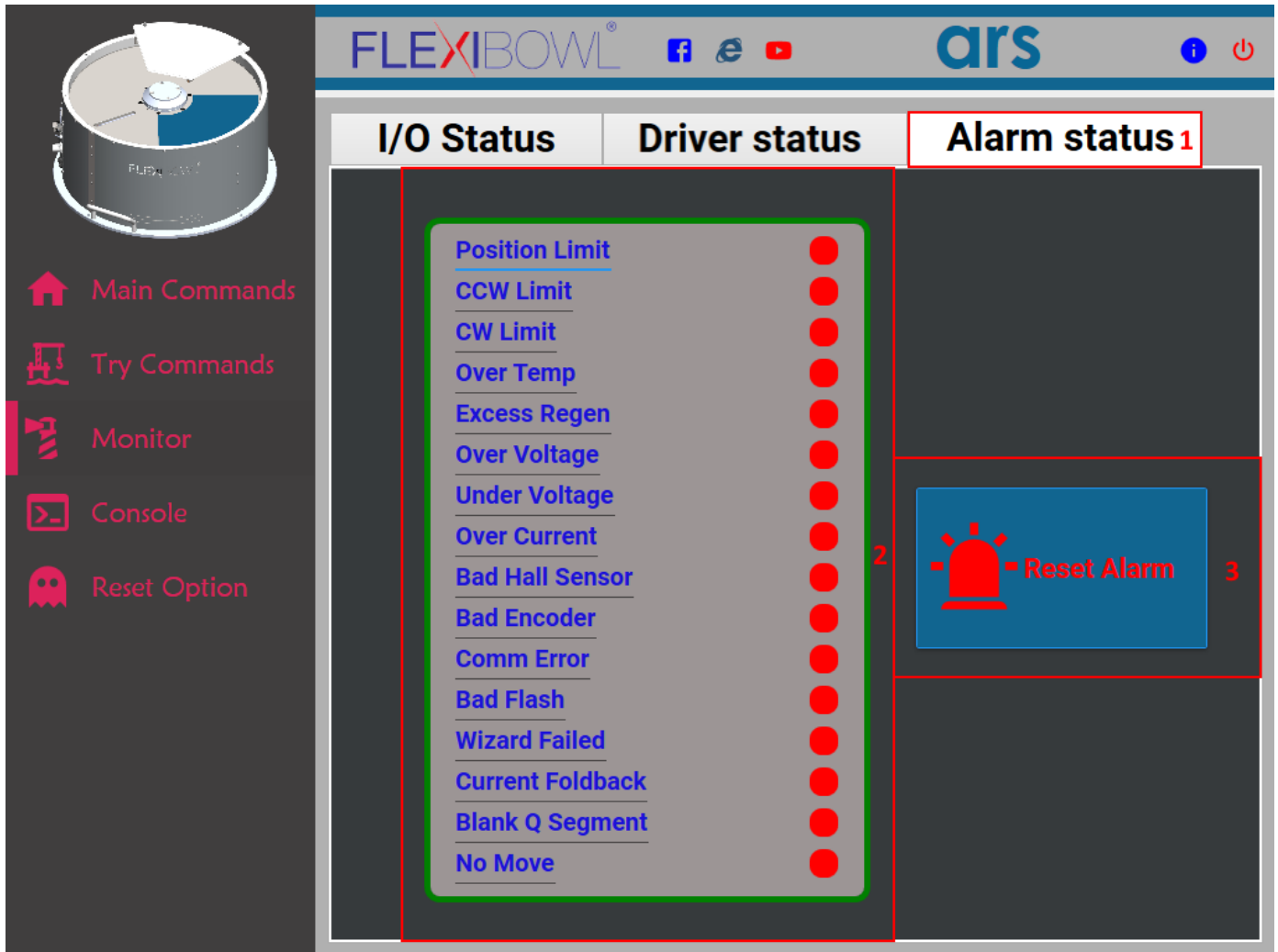

Pos.	Elemento	Descrizione
1	Alarm Status	It is used to view the Alarm present in the FlexiBowl®
2	Alarm	Type of alarm present in the FlexiBowl®
3	Reset Alarm	It resets the FlexiBowl® alarms

## 6.2.7 Console

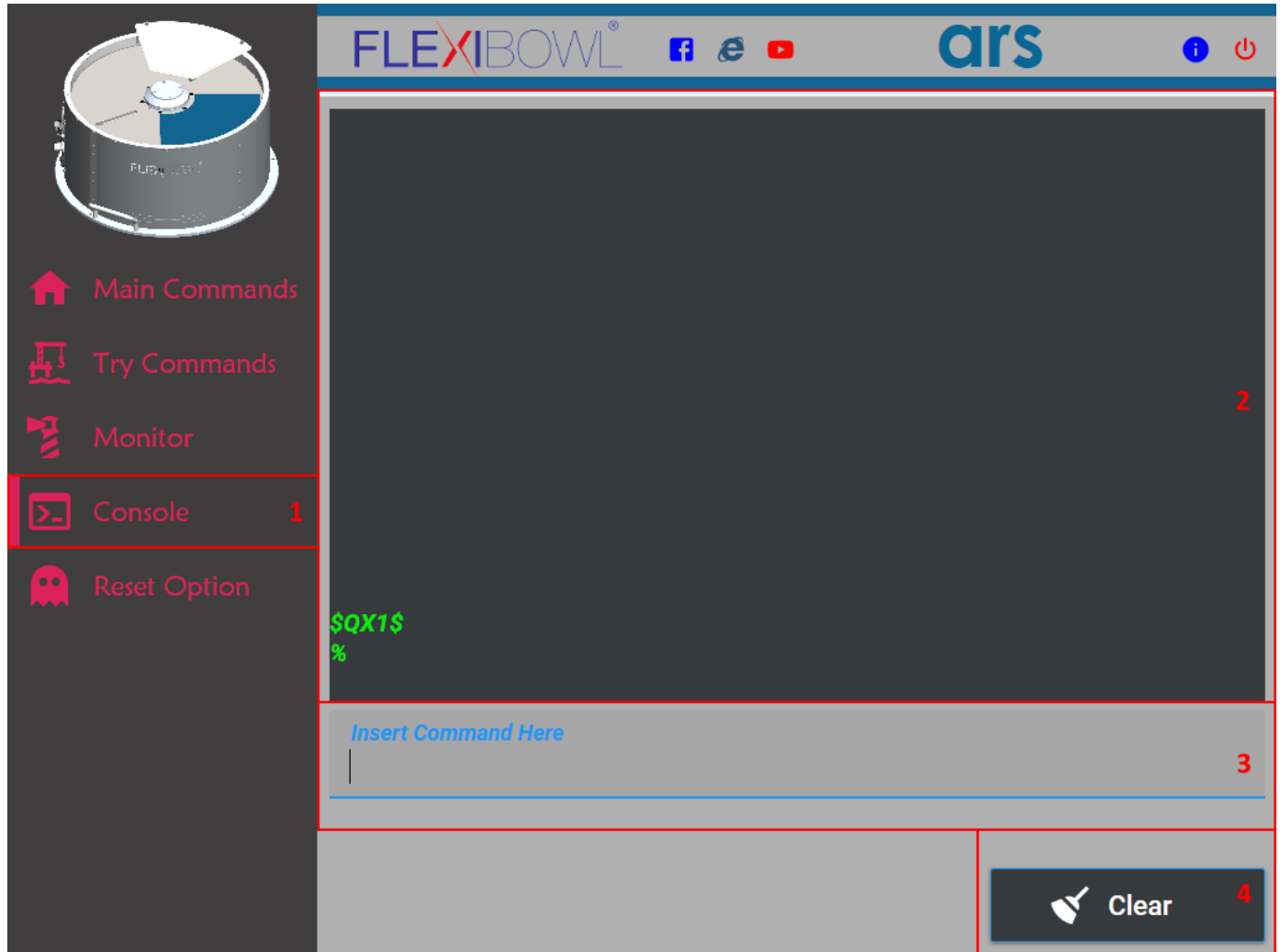

Pos.	Item	Description
7	Console	It is used to send a command to the driver.
7.A	Command Window	Command terminal window.
7.B	Command area	It is used to send a command to the driver. <b>Note:</b> The command is sent when is pressed "enter".
7.C	Clear All	It clears the command terminal window.



### 6.2.8 Reset Option

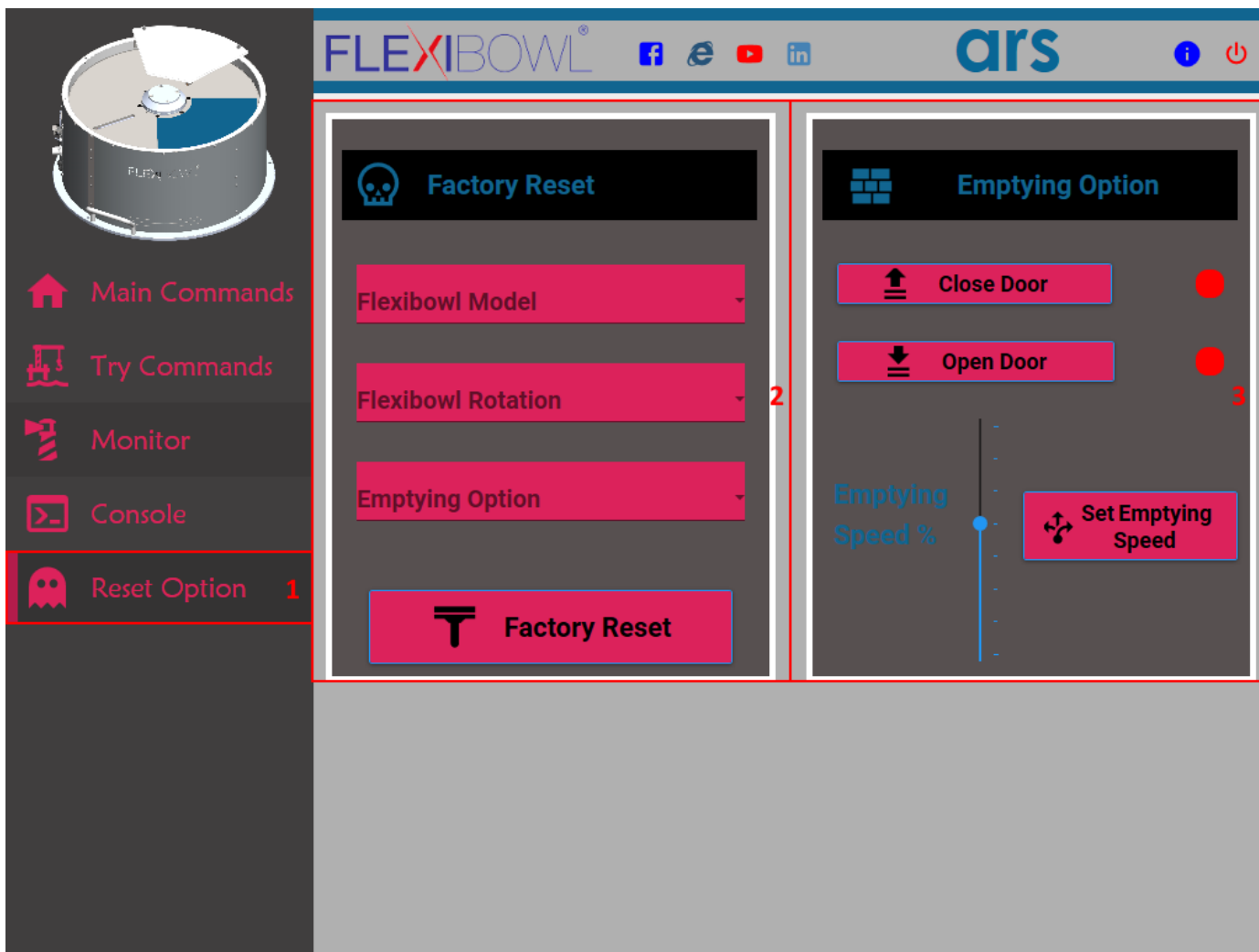

Pos.	Elemento	Descrizione
1	Reset Option	It is used to reset the FlexiBowl® at factory default status and commands the empty door manually.
2	Factory Reset	It resets the FlexiBowl® at factory default status. Before pressing the <b>Factory Reset</b> button you have to select the FlexiBowl® model ( <b>FlexiBowl Model</b> ), if the FlexiBowl® is clockwise or counterclockwise ( <b>FlexiBowl Rotation</b> ) and if the Quick Emptying Option is present
3	Empetying Option	It is used to command the Quick Emptying Door manually. It's also possible see the status of the opening and closing Door sensors and set the Emptying speed.

## 6.3 Operating procedures



### CAUTION!

After carrying out the transport and installation operations, and before starting the machine, make sure the robot vision system has been calibrated. Contact ARS S.r.l. to calibrate the vision system.

### 6.3.1 Preliminary inspections

Before starting the machine, the following checks need to be carried out:

- Check that the machine is placed on a surface that can withstand its weight.
- Make sure the safety devices are working properly.
- Make sure all opening guards are closed properly.
- Check that the space around the machine is free from obstacles and/or obstructions.
- Check that the machine is connected to the mains.
- Check that the power supply phases are correct.
- Check **that the surface is free to rotate**.
- Check **that the Flip can run its stroke without obstruction**.
- Check that the machine is not under "Maintenance".

### 6.3.2 Start-up



### CAUTION!

When the compressed air is first supplied, the Flip unit may move unexpectedly. Before turning the air on, make sure that:

- the power supply is fully assembled,
- the Flip shield is in place,
- there is nobody near the FlexiBowl®.

Proceed as described to **start** the machine:

Pos.	Action
1	Operate the power switch
2	Make sure that the green "Ready-Fault" light on the control panel is on. If it is not, check the 110 - 230 Vac power supply.

### 6.3.3 Programming



### IMPORTANT!

The machine must only be programmed by expert and qualified personnel.

The **FlexiBowl®** can be managed and programmed in one of the following ways:

- Programming with TCP/IP - UDP protocol.
- Programming with digital I/O.
- Programming with Ethernet/IP

### 6.3.3.1 Programming with TCP/IP – UDP protocol



#### IMPORTANT!

The default IP addresses is 192.168.1.10 in class B (Subnet Mask 255.255.0.0). The TCP/IP port is 7776 and the UDP port is 7775.

The correct syntax for each pack is:

Header	Description	Footer
Chr(0)	Chr(7)	Command (ASCII character vector)
		Chr(13)

For each string sent to the FlexiBowl®, an ECHO of the command received will be returned. If the string is interpreted correctly, the ECHO will be:

Header	ECHO	Footer
Chr(0)	Chr(7)	%
		Chr(13)

Otherwise if the string is not interpreted correctly, the ECHO will be:

Header	ECHO	Footer
Chr(0)	Chr(7)	?
		Chr(13)

Once you are connected to the FlexiBowl®, simply send the following commands (in ASCII character vectors) to obtain the result described:

Command	Action	Description
<b>QX2</b>	Move	Moves the FlexiBowl® with the current parameters
<b>QX3</b>	Move - Flip	Moves the FlexiBowl® and activates the Flip during the movement.
<b>QX4</b>	Move - Blow - Flip	Moves the FlexiBowl® and activates the Flip and the second valve during the movement.
<b>QX5</b>	Move - Blow	Moves the FlexiBowl® and activates the second valve during the movement.
<b>QX6</b>	Shake	Shakes the FlexiBowl® with the current parameters.
<b>QX7</b>	Light on	Turns the backlight on.
<b>QX8</b>	Light off	Turns the backlight off.
<b>QX9</b>	Blow	Turns the Air blow on with the current parameters.
<b>QX10</b>	Flip	Turns the Flip on with the current parameters.
<b>QX11</b>	Quick Emptying	Perform the Quick Emptying sequence of the FlexiBowl®
<b>QX12</b>	Reset Alarm	Reset the alarm and enable the motor
<b>SO2L</b>	Raises signal 2	Turns on the Flip valve (the Flip remains high)
<b>SO2H</b>	Lowers signal 2	Turns off the Flip valve (the Flip lowers)
<b>SO3L</b>	Lifts signal 3	Turns the Air Blow on
<b>SO3H</b>	Lowers signal 3	Turns the Air Blow off
<b>SO4L</b>	Lifts signal 4	Turns the backlight on
<b>SO4H</b>	Lowers signal 4	Turns the backlight off

**Note:** To know if the FlexiBowl® has finished the command, use the following procedure:

Send the “**Chr(0)Chr(7)IO**(ASCII character vector)**Chr(13)**” command. The answer will be the status of the various FlexiBowl® inputs and outputs. If the least significant bit of the answer is 1, the FlexiBowl® has finished the movement and is ready to accept another command.

**To reset a FlexiBowl® alarm** via ethernet, must be sent the following command:

**Chr(0)Chr(7)QX12**(ASCII character vector)**Chr(13)** to reset the alarm and enable the motor

**To know if the FlexiBowl is Faulty**, send the command “**Chr(0)Chr(7)IOY**(ASCII character vector)**Chr(13)**”.

**Note:** if any movement command is sent and the “**Quick emptying option**” door is low, the FlexiBowl® will go in Fault

To set the various handling parameters of the FlexiBowl®, use the volatile support register 1. Use the following command to perform this operation:

Command	Action	Description
<b>RL1 Value</b>	Support register 1 = Value	Enter a value in the support register. <b>Example:</b> RL1 100 enter value 100 in the volatile register 1
<b>RW1Non volatile register</b>	Non volatile register = support register 1	Transfer the value of volatile register 1 into the non volatile register <b>Example:</b> RW12 transfer the value of volatile register 1 to non volatile register 2 which corresponds to the deceleration used for each subsequent Move command

**Parameters:**

Non volatile register	Description	Default values	Range
<b>1</b>	Acceleration used for each subsequent Move command.	250	1 - 500
<b>2</b>	Deceleration used for each subsequent Move command.	250	1 - 500
<b>3</b>	Speed, in RPM, at which the FlexiBowl® will advance at each subsequent Move command.	250	1 - 500
<b>4</b>	Angle by which the FlexiBowl® will advance at each subsequent Move command.	45	-360 - 360
<b>5</b>	Acceleration used for each subsequent movement of the Shake.	250	1 - 500
<b>6</b>	Deceleration used for each subsequent movement of the Shake.	250	1 - 500
<b>7</b>	Number of movements, in alternate directions, that are made with every Shake instruction. <b>Example:</b> sh_count=3 means that the FlexiBowl® will move counterclockwise at an angle of ccw_angle, clockwise at an angle of cw_angle, for 3 times.	1	positive
<b>8</b>	Clockwise angle the FlexiBowl® moves for each shake at subsequent Shake command.	45	-360 - 360
<b>9</b>	Counterclockwise angle the FlexiBowl® moves for each shake at subsequent Shake command.	-45	-360 - 360
<b>10</b>	Speed, in RPM, at which to shake the FlexiBowl® at each subsequent shake command.	250	1 - 500
<b>11</b>	Number of ON/OFF cycles that the Flip will perform at each subsequent Flip instruction.	2	positive
<b>12</b>	Time, in milliseconds, between an ON and an OFF of the Flip at each subsequent Flip command.	50	positive
<b>13</b>	Air Blowing time, in milliseconds.	200	positive

**Example:**

If you want to set the acceleration of the FlexiBowl® movement, you will have to send the following commands:

- **“Chr(0)+Chr(7)+RL1 100** in ASCII character vectors**+Chr(13)”** for the volatile register to assume the value 100;
- **“Chr(0)+Chr(7)+RW11** in ASCII character vectors**+Chr(13)”** to transfer the contents of volatile register 1 to permanent register 1 which corresponds to the acceleration used for each subsequent Move command;

### 6.3.3.2 Programming and handling via digital I/O



**CAUTION!**  
Disconnect the input connectors, if connected.

The program to modify the movement parameters of the FlexiBowl® is on the USB flash drive, sent with the system. Proceed as follows for programming using the digital I/O:

Step	Action
1	Use the FlexiBowl® Parameters utility supplied by ARS S.r.l. to set the movement parameters.
2	From utility, enable the Enable Digital I/O function.
3	Turn the FlexiBowl® off and then on again.
4	Wait for the Ready/Fault LED to turn green, after about 2 seconds the FlexiBowl® will be in I/O mode.

The operating principle is as follows:

- Apply 24Vdc to the input relating to the command to be carried out for about 50ms. The Busy output will be ON for the entire duration of the movement.
- The Busy output is available between Pin 1 and 5 of the Output connector.



**IMPORTANT!**  
Do not send a new movement command until the Busy signal is OFF. Otherwise the command will be ignored.

#### INPUTS TABLE:

PIN	Command
1	Move
2	Move - Flip
3	Move - Blow - Flip
4	Move - Blow
5	Shake
6	Light on
7	Light off
8	Flip
9	Reset Alarm
10	Quick Emptying option
11	Emptying Door open (read only)
12	Emptying Door closed (read only)

**Note:** if any movement command is sent and the “Quick emptying option” door is low, the FlexiBowl® will go in Fault

### 6.3.3.3 Programming with Ethernet/IP

The FlexiBowl® can be programmed and controlled from the PLC by the Ethernet/IP protocol. The PLC must be equipped with a suitable port to communicate with the aforesaid protocol and must be configured with the correct .eds files.

The program must be provided with a special data structure to interface with the registers of the FlexiBowl® control system.

### 6.3.4 Pressure adjustment

To adjust the pressure:

Step	Action
1	Pull the knob on the power supply body and turn it. <b>Note:</b> turning it counterclockwise will lower the pressure, turning it clockwise will increase it.
2	When the pressure has been adjusted as required, push the knob towards the power supply and the setting will automatically be locked in. <b>Note:</b> This prevents accidental changes to the pressure settings.
3	The set pressure is displayed on the control panel's screen

### 6.3.5 Switching off

Proceed as described to switch the machine off:

Step	Action
1	Check that the machine has finished the work process.
2	Disconnect the power switch.

## 7 Maintenance



**CAUTION! Perform maintenance operations when the machine is turned off.**



**CAUTION!**  
**Maintenance operations must be carried out by qualified and authorised personnel.**

Machine maintenance includes the operations (inspections, checks, adjustments and replacements) that become necessary following normal use.

**For good maintenance:**

- only use original spare parts and tools that are suitable for the purpose and in good condition.
- follow the intervention frequencies indicated in the manual for scheduled maintenance (preventive and periodic). The distance (indicated in time or in work cycles) between one intervention and another is intended as the maximum acceptable; therefore, it must not be exceeded, but it can be shortened.
- good preventive maintenance requires constant attention and continuous monitoring of the machine. Immediately check the cause of any anomalies, such as excessive noise, overheating, fluid leaks, etc., and fix it.
- timely removal of any causes of anomaly or malfunction prevents further damage to the equipment and ensures operator safety.

Machine maintenance staff must be well trained and have thorough knowledge of the accident prevention regulations; unauthorised staff must stay outside the work area during the operations.

Machine/system cleaning and adjustments must also be carried out only during maintenance and with the machine/system stopped and disconnected from the electrical panel, as shown in the use and maintenance manual.



**IMPORTANT!**  
**In case of doubt, it is forbidden to operate. Contact the Manufacturer for any explanations.**



**CAUTION!**  
**Any repairs or maintenance work not indicated herein can only be carried out following authorisation from ARS S.r.l. ARS S.r.l. shall not be held liable for any damage to people or property for operations other than those described or carried out in ways different than indicated.**

Machine maintenance jobs, in terms of operation, are divided into two main categories:

<p><b>Routine maintenance</b></p>	<p>All those operations that the operator must perform preventively to ensure smooth operation of the machine over time; routine maintenance includes inspections, checks, adjustments, cleaning and lubrication.</p>
<p><b>Unscheduled maintenance</b></p>	<p>All those operations that the operator must perform when required by the machine. Unscheduled maintenance includes inspections, repairs, restoration of nominal operating conditions or replacement of a broken, faulty or worn unit.</p>



## 7.1 Safety warnings



### CAUTION!

Before starting any maintenance work on the machine, disconnect and padlock all energy sources and safely block all of its moving units. Put the “Machine under maintenance – do not switch on” sign on the main switch.



### CAUTION!

To stop the machine from being accidentally switched on while it is under maintenance, put signs on it saying: “CAUTION! Machine Under Maintenance”.

- Maintenance technicians must wear the necessary personal protective equipment (gloves, glasses, overalls) for the job at hand.
- During maintenance operations, unauthorised personnel must remain outside the operation area.
- If the operation requires the guards to be removed, the area of intervention must be fenced off and persons unrelated to the maintenance work must be forbidden access.

The need to put the machine in working condition and/or with the protections disabled requires adequate skill and knowledge, and extreme care by the maintenance technician who must be appropriately trained on possible and subsisting risks.

The accident prevention precautions in this section must always be strictly adhered to during machine/system maintenance, in order to prevent injury to personnel and damage to the equipment.

Before starting any maintenance work, ensure that the energy sources are disconnected (electricity, compressed air, hydraulic energy, etc.).

- Carry out the operations only with the machine/system stopped and disconnected.
- Put up specific warning signs such as: EQUIPMENT UNDER MAINTENANCE – DO NOT POWER ON, WORK IN PROGRESS – DO NOT OPERATE or **do not switch On** at the main switch and in the machine access zones.
- Carry out the operations covered by the skillset (Mechanical, Electrical, Fluid) that you are authorised for.
- Be able to use the most suitable and appropriate instrumentation for troubleshooting and know the most suitable equipment for maintenance.

## 7.2 Routine maintenance

When the machine is delivered to the user, it is already adjusted to work properly; however, in order to ensure smooth operation over time, periodic and preventive checks and maintenance work must be carried out.

**Routine maintenance** includes inspections, checks and interventions that, to prevent breakdowns, keep the following under control:

- the mechanical conditions of the machine,
- cleanliness of the machine.

The following tables list a series of checks and interventions to be carried out following a recommended timetable. The frequency of the routine maintenance operations indicated refers to normal operating conditions, i.e. that meet the intended conditions of use.

The table below lists a series of routine maintenance procedures valid for all types of machines manufactured by ARS S.r.l.

The operator must take into consideration only the procedures relating to the machine described in this manual.



**IMPORTANT!**

**For the routine maintenance of machines from external suppliers, see the sub-supplier manuals for said machines attached hereto.**



**IMPORTANT!**

**Always use LOCTITE 243 threadlocker to ensure the screws are properly secured (except for the flange screws on the FlexiBowl® Rotary Disc).**

## 7.2.1 Checks and inspections

### 7.2.1.1 Routine maintenance table - checks

Operation	Frequency				
	Daily	Weekly	Monthly	Six-monthly	Yearly
Check that the general pressure regulator works properly.				◆	
Check that the safety devices work properly.				◆	
Check the <b>Rotary Disc</b> conditions before every start-up.	◆				
	<b>(Replace at least once a year)</b>				
Check for wear of the relays.					◆
Check that the fuses works properly.					◆
Check for wear of the FlexiBowl®.		◆			
	<b>(Replace completely according to the degree of wear)</b>				
Check that the solenoid valves work properly.				◆	
	<b>(Completely replace every 2 years)</b>				
Checking for wear of the drill.			◆		
	<b>(Completely replace every year)</b>				

### 7.2.1.2 Inspection of safety devices

Perform the following checks to ensure that the safety devices work properly:

Step	Action
1	Check that the machine covers are in place and fixed properly.
2	Check that the power cable is not damaged and/or worn

### 7.2.1.3 Checking for wear of the drill

Proceed as follows to check for wear of the drill:

Step	Action	Picture
1	Disconnect the power and air supply of the machine.	
2	Take the cover off the FlexiBowl®.	
3	Visually check for wear of the drill.	

### 7.2.1.5 Checking for wear of the relays and status of the fuses

Visually check for wear of the relays.

There are: 3 static relays (which respectively command Busy, Flip and Air Blow) and 3 mechanical relays (which control the “READY/FAULT” STATUS LED on the control panel, the Quick Emptying option and the backlight). There are also 4 protection fuses.

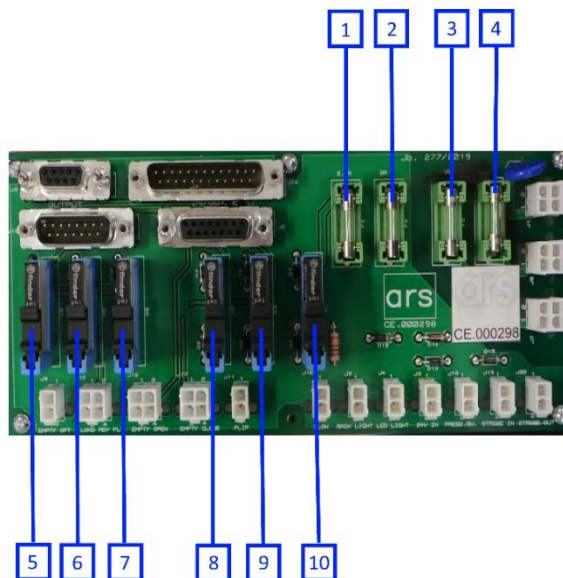



Position	Item
1	24Vdc protection fuse (2.5A)
2	Light protection fuse in strobe mode (2A)
3	24Vdc power supply unit protection fuse (1A)
4	Driver supply protection fuse (3A)
5	Quick Emptying
6	Ready/Fault status LED
7	Busy
8	Flip
9	Air Blow
10	Backlight

### 7.2.2 Replacing the FlexiBowl® Rotary disc

The FlexiBowl® **Rotary Disc** must be replaced according to the following conditions:

- at every format change: each component format may require a different **Rotary Disc** to be used;
- **every 3 months**: the **Rotary Disc** should be replaced every 3 months if used with particularly sharp components;
- **yearly**: in any case, it is recommended to replace the **Rotary Disc** at least once a year.

Proceed as follows to replace the **Rotary Disc** of the FlexiBowl®:

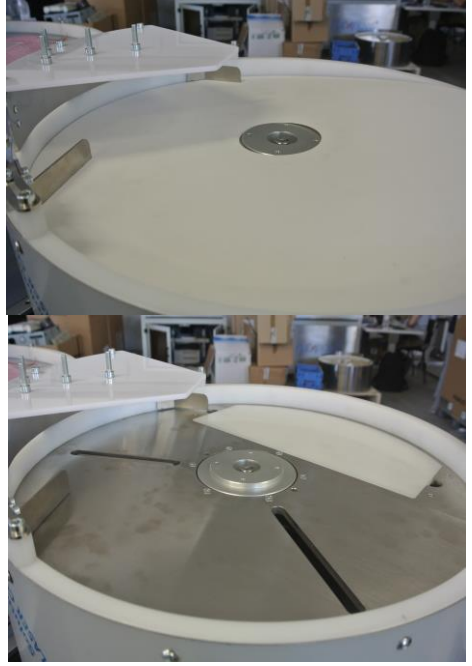
Step	Action	Picture
1	Use an Allen key to unscrew the flange fixing screws without removing them.	
2	Turn the flange counterclockwise and remove it.	
3	Remove the <b>Rotary Disc</b> and replace it.	
4	Fit a new <b>Rotary Disc</b> on and tighten the fixing screws to 10 Nm.	

### 7.2.3 Cleaning



**CAUTION!**  
Cleaning operations must be carried out by qualified and authorised personnel.



**CAUTION!**  
To clean the machine, do not use bits of sponge, damp and/or abrasive cloths, rags with loose threads, petrol or flammable solvents as detergent.



**IMPORTANT!**  
Use neutral, non-abrasive products such as degreasers or common household soap. To remove fragments and dust, use a brush and wear safety glasses.



**CAUTION!**  
Do not use acids or solvents to clean the Rotary Disc.

#### 7.2.3.1 Routine maintenance table – cleaning

Operation	Frequency				
	Daily	Weekly	Monthly	Six-monthly	Yearly
Remove processing residues and waste from the <b>Rotary Disc</b> .	◆				
Remove any grease or oil with neutral products or solvents.	◆				
Clean the air filter.				◆	
Clean the FlexiBowl® <b>Rotary Disc</b> .		◆			
	(and whenever it is dirty following a visual check)				
General cleaning.		◆			

**7.2.3.2 Cleaning the air filter**

Proceed as described below to clean the air filter:

Step	Action	Picture
1	Disconnect the power and air supply of the machine.	
2	Take the cover off the FlexiBowl®.	
3	Rotate the filter holder to unlock it and remove it.	
4	Clean it with compressed air.	
5	Put the filter holder back in place.	



### 7.2.4 Cleaning the FlexiBowl® Rotary Disc

Proceed as follows to **clean the FlexiBowl® Rotary Disc**:

Step	Action	Picture
1	Unscrew the flange fixing screws with an Allen key, and leave them in position.	
2	Turn the flange counterclockwise and remove it.	
3	Remove the <b>Rotary Disc</b> and clean it with alcohol or degreaser. Also clean its support surface with degreaser.	
4	After cleaning, fit the <b>Rotary Disc</b> back on and tighten the fixing screws to 10 Nm.	

### 7.2.4.1 General cleaning

The machine must be kept in a good condition of cleanliness.

Proceed as described below to **give the machine a general clean**:

Step	Action
1	Disconnect the power and air supply of the machine.
2	Manually remove any product residues.
3	Remove the dirt with non-flammable and non-toxic commercial cleaning solvents.
4	If necessary, use a vacuum cleaner to remove any residues from the <b>Rotary Disc</b> .
5	After cleaning, restore all machine connections.



**IMPORTANT!**

**The machine must be given a general cleaning whenever the type of component to be processed is changed, in order to remove any residues from previous processes.**

### 7.3 Unscheduled maintenance



**CAUTION!**

**Unscheduled machine maintenance and repairs shall only be carried out by qualified, trained and authorised technicians, employed by the Manufacturer or by the authorised service centre. These interventions require thorough and specialised knowledge of the machine, of the operations required, of the risks involved and of the correct procedures to work safely.**

If exceptional events occur, which require unscheduled maintenance work to be carried out, the user's routine maintenance technicians must follow these procedures:

- check the condition of the damaged or out-of-phase units;
- perform the operations described in this section;
- if the operations to be carried out are not indicated in this manual, send the report of what occurred, the result of the inspection and any observations to the Manufacturer.

The Manufacturer or the authorised service centre will evaluate the situation case by case. Then the type of work to be carried out will be agreed with the routine maintenance technicians, and the most suitable solution will be chosen from the list below:

- the Manufacturer will send an authorised, trained and qualified technician to carry out the necessary work;
- or the Manufacturer will authorise the user's routine maintenance technicians to carry out the work and send any additional instructions.



**CAUTION!**

**Replacement spare parts must be ordered from ARS S.r.l.**

**If the customer does not use spare parts that are original or authorised in writing by the Manufacturer, the latter shall be deemed free from any liability concerning machine operation and operator safety. Authorisation and/or instructions must always be provided in writing. In the absence of written authorisation, it is forbidden to operate and the Manufacturer disclaims all liability.**



**CAUTION!**

**Maintenance operations must be carried out only by qualified and authorised personnel.**



**CAUTION!**

**Disconnect the power supply before taking the cover off.**



**CAUTION!**

**Disconnect the power and air supply before starting any maintenance operations.**



**IMPORTANT!**

**Always use LOCTITE 243 threadlocker to ensure the screws are properly secured (except for the flange screws on the FlexiBow!® Rotary Disc).**

### 7.3.1 Replacing the backlight



**IMPORTANT!**

The infrared backlight shines an invisible light and therefore may not appear to be working. Use a camera with an infrared filter to check that it is working properly.

**Note:** most smartphones can see infrared lights.

REPLACING THE BACKLIGHT	
Operator qualification	Mechanical maintenance technician
PPE required	
Tools to be used	Allen key, small Phillips screwdriver



**CAUTION!**

Disconnect the power supply before taking the cover off.

Proceed as follows to replace the backlight:

Step	Action	Picture
1	Follow the procedure described in Chapter 7.2.2 "Replacing the FlexiBowl® Rotary Disc" up to point 3	
2	Remove the Lexan guard that protects the light (use the side slots provided)	
3	Remove the 4 screws that secure the light board to the surface	
4	Remove the light board using the relative towers	
5	Remove the light cable and disconnect the connector.	
6	Connect the new light and install it in the correct position	
7	Once replaced, reassemble all components	

### 7.3.2 Replacing the solenoid valve

REPLACING THE SOLENOID VALVE	
Operator qualification	Mechanical maintenance technician
PPE required	
Tool to be used	Allen key; Phillips screwdriver



**CAUTION!**  
**Disconnect the power supply before taking the cover off.**

Proceed as follows to replace the solenoid valve on models 200 and 350:

Step	Action	Picture
1	Unplug the power cable from the control panel.	
2	Take the cover off the FlexiBowl®.	
3	Remove the solenoid valve power cable.	
4	Unscrew the 2 fixing screws (A). <b>Note:</b> keep the removed screws for reassembly.	
5	Remove the solenoid valve and replace it with one with the same characteristics.	

Proceed as follows to replace the solenoid valve on models 500, 650 and 800:

Step	Action	Picture
1	Unplug the power cable from the control panel.	
2	Follow the procedure to replace the backlight described in Chapter 7.3.1 up to point 4	
3	Remove the solenoid valve power cable.	
4	Unscrew the 2 fixing screws (A). <b>Note:</b> keep the removed screws for reassembly.	
5	Remove the solenoid valve and replace it with one with the same characteristics.	

### 7.3.3 Replacing the anti-vibration mount

REPLACING THE ANTI-VIBRATION MOUNTS	
Operator qualification	Mechanical maintenance technician
PPE required	
Tool to be used	Allen key

Proceed as follows to replace the anti-vibration mounts:

Step	Action	Picture
1	Disconnect the power supply and remove the cover	
2	Remove the worn rubber mount and replace it with a new one having the same features.	

### 7.3.4 Replacing the Driver

REPLACING THE DRIVER	
Operator qualification	Mechanical maintenance technician
PPE required	
Tools to be used	Allen key



**CAUTION!**  
Disconnect the power supply before taking the cover off.

Proceed as follows to replace the Driver:

Step	Action	Picture
1	Unplug the power cable from the control panel.	
2	Take the cover off the FlexiBowl®.	
3	Remove the Driver connectors.	
4	Unscrew the 2 fixing screws.	
5	Insert the new Driver. <b>Note:</b> the Driver will arrive with standard IP address 192.168.1.10 and Subnet mask 255.255.255.0.	



### 7.3.5 Replacing the power supply unit

REPLACING THE POWER SUPPLY UNIT	
Operator qualification	Mechanical maintenance technician
PPE required	
Tool to be used	Allen key



**CAUTION!**  
Disconnect the power supply before taking the cover off.

Proceed as follows to replace the power supply unit:

Step	Action	Picture
1	Unplug the power cable from the control panel.	
2	Take the cover off the FlexiBowl®.	
3	Remove the power cables.	
4	Remove the fixing screws.	
5	Insert the new power supply. <b>Note:</b> the red cables plug into + on the power supply and the black cables plug into -.	



### 7.3.6 Replacing the motor

REPLACING THE MOTOR	
Operator qualification	Mechanical maintenance technician
PPE required	
Tool to be used	Allen key



**CAUTION!**  
Disconnect the power supply before taking the cover off.

Proceed as follows to replace the motor on models 200 and 350:

Step	Action
1	Unplug the power cable from the control panel.
2	Take the cover off the FlexiBowl®.
3	Take the <b>Rotary Disc</b> off.
4	Loosen the shrink disk that attaches the flange to the motor.
5	Remove the flange.
6	Remove the shrink disk.
7	Remove the 4 screws that fix the motor to the FlexiBowl®.
8	Replace the motor with one with the same characteristics. <b>Note:</b> the flange must be installed at 1.5 mm from the sliding <b>Rotary Disc</b> .

Proceed as follows to replace the motor on models 500, 650 and 800:

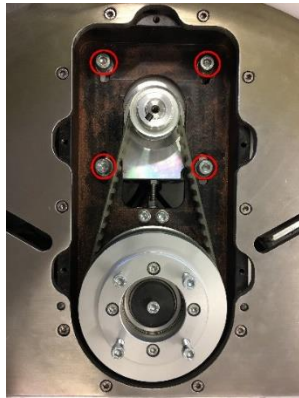
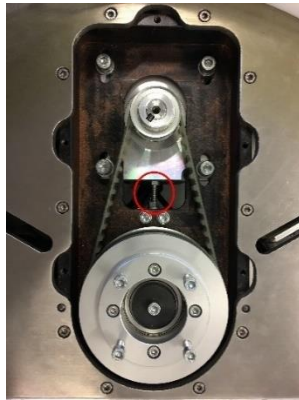
Step	Action	Picture
1	Unplug the power cable from the control panel.	
2	Take the cover off the FlexiBowl®.	
3	Take the <b>Rotary Disc</b> off. Refer to the procedure described in Chapter 7.2.2	
4	Remove the cover by unscrewing the screws that secure it to the surface	
5	Loosen the screws of the motor	
6	Loosen the screw that tensions the belt until it is possible to remove the belt from the motor's pulley	
8	Disconnect the motor's cables from the driver (motor power supply cable and encoder cable)	
7	Remove the screws of the motor, being careful not to drop the said motor by force of gravity <b>Note:</b> the encoder is situated under the motor	
9	Replace the motor with one with the same characteristics and tension the belt as required	

## 7.4 Troubleshooting

No.	Problem	Solution
1	The status LED (Ready/Fault) is red.	<ul style="list-style-type: none"> <li>• If the FlexiBowl® is working, check operation of the LED or the mechanical relay inside the interface.</li> <li>• Check the condition of the fuse inside the power input module and replace it if necessary.</li> <li>• Check that no parts prevent free movement of the <b>Rotary Disc</b></li> </ul> <p><b>Note:</b> if the problem persists, contact ARS S.r.l.</p>
2	The FlexiBowl® vibrates/oscillates excessively.	<ul style="list-style-type: none"> <li>• Check that the screws are tightened properly.</li> <li>• Check if the load of FlexiBowl® is within the permitted parameters based on the model.</li> <li>• Try to decrease the movement parameters (acceleration, deceleration, speed)</li> </ul> <p><b>Note:</b> if the problem persists, contact ARS S.r.l.</p>
3	The status LED (Ready/Fault) is off.	<ul style="list-style-type: none"> <li>• Check that the power supply is correct and working.</li> <li>• Check the condition of the fuses inside the interface board and replace it if necessary.</li> </ul> <p><b>Note:</b> if the problem persists, contact ARS S.r.l.</p>
4	The Flip does not work.	<ul style="list-style-type: none"> <li>• Check that the screen displays the correct pressure</li> <li>• Check the air pressure inside the air supply system control panel.</li> <li>• Check the condition of the pressure regulator.</li> <li>• Check that the power supply is correct and working.</li> <li>• Check that the valves work properly.</li> <li>• Make sure the valve relay inside the interface is working properly.</li> <li>• Check the condition of the fuse inside the interface and replace it if necessary.</li> </ul> <p><b>Note:</b> if the problem persists, contact ARS S.r.l.</p>
5	The Air Blow does not work.	<ul style="list-style-type: none"> <li>• Check that the screen displays the correct pressure</li> <li>• Check the air pressure inside the air supply system control panel.</li> <li>• Check the condition of the pressure regulator.</li> <li>• Check that the power supply is correct and working.</li> <li>• Check that the valves work properly.</li> <li>• Make sure the valve relay inside the interface is working properly.</li> <li>• Check the condition of the fuse inside the interface and replace it if necessary.</li> </ul> <p><b>Note:</b> if the problem persists, contact ARS S.r.l.</p>

No.	Problem	Solution
6	The backlight does not work.	<ul style="list-style-type: none"><li>• Check that the power supply is correct and working.</li><li>• Check operation of the backlight relay inside the interface.</li><li>• Check the condition of the fuse inside the interface and replace it if necessary.</li></ul> <p><b>Note:</b> if the problem persists, contact ARS S.r.l.</p>

## 8 Decommissioning and disposal



### CAUTION!

Decommissioning and dismantling operations must be assigned to personnel specialised in such activities. Namely, only the person in charge of dismantling and disposal at the end of the service life can:

- disconnect the parts mechanically and electrically following the disassembly instructions and blueprints.
- transport the parts from the system site to the disposal centre for sorting the parts.

The machine mainly consists of the following materials:

- painted, plasticised or galvanised ferritic steel;
- 300/400 series stainless steel;
- plastic polyethylene material;
- elastomers, PTFE, graphite;
- gear oil;
- lubricating grease;
- electric motors;
- power cables with relative sheaths;
- electronic control and actuation devices.
- etc.



### CAUTION!

The machine does not contain any components or hazardous substances that require special removal procedures.

### 8.1 Decommissioning

If the machine will not be used for a long time, it must be made safe and stored properly. Proceed as described:

Step	Action
1	Disconnect the power supply.
2	Disconnect the air supply.
3	Protect electrical equipment that is particularly prone to wear over time and dust.



### IMPORTANT!

When decommissioning machines from external suppliers, see the sub-supplier manuals for said machines attached hereto.

### 8.3 Disposal

Machine scrapping operations must be assigned to qualified personnel, each for their own area of expertise. When the machine will be disposed of, make sure it is made safe.



**CAUTION!**  
**Disconnect the power and air supply of the machine.**



**CAUTION!**  
**For disassembly of trade parts or sub-supply materials that are part of the machine supplied by ARS S.r.l. please see the relative supplier's manual.**

Pursuant to the "WEEE" Directive 2012/19/EU, if the component/equipment purchased is marked with the following crossed-out wheelie bin, it means that at the end of its service life the product must be collected separately to other waste.



**CAUTION!**  
**It is mandatory to comply with the laws in force regarding disposal in the country of machine installation.**

## 9 APPENDICES

Appendix
<b>A: FlexiBowl® Rotary Discs</b>
<b>B: FlexiBowl® 2.0: what changes</b>
<b>C: New FlexiBowl® Options</b>



**ARS S.r.l.**

Via G. Vico, 7 – 52100 Arezzo (AR) Italia  
Tel. +39 0575 398611 - Fax +39 0575 398620  
[info@arsautomation.com](mailto:info@arsautomation.com) - [www.arsautomation.com](http://www.arsautomation.com)